

G D

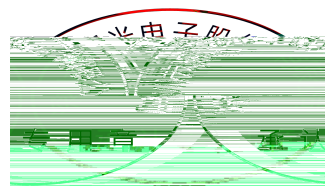

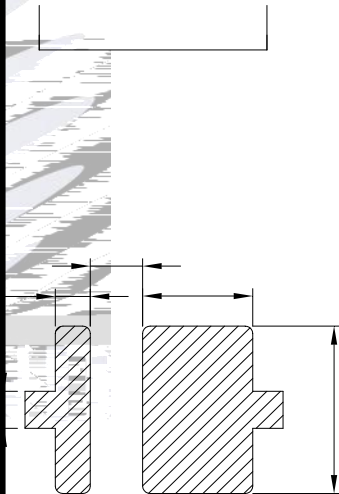

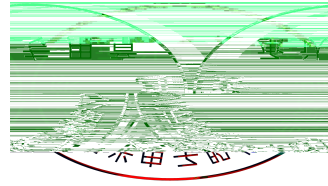

QAYEUA



豐光電

SHANGHAI

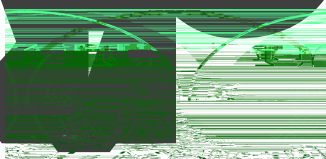

尔甲士加



μ XINRICH

30M

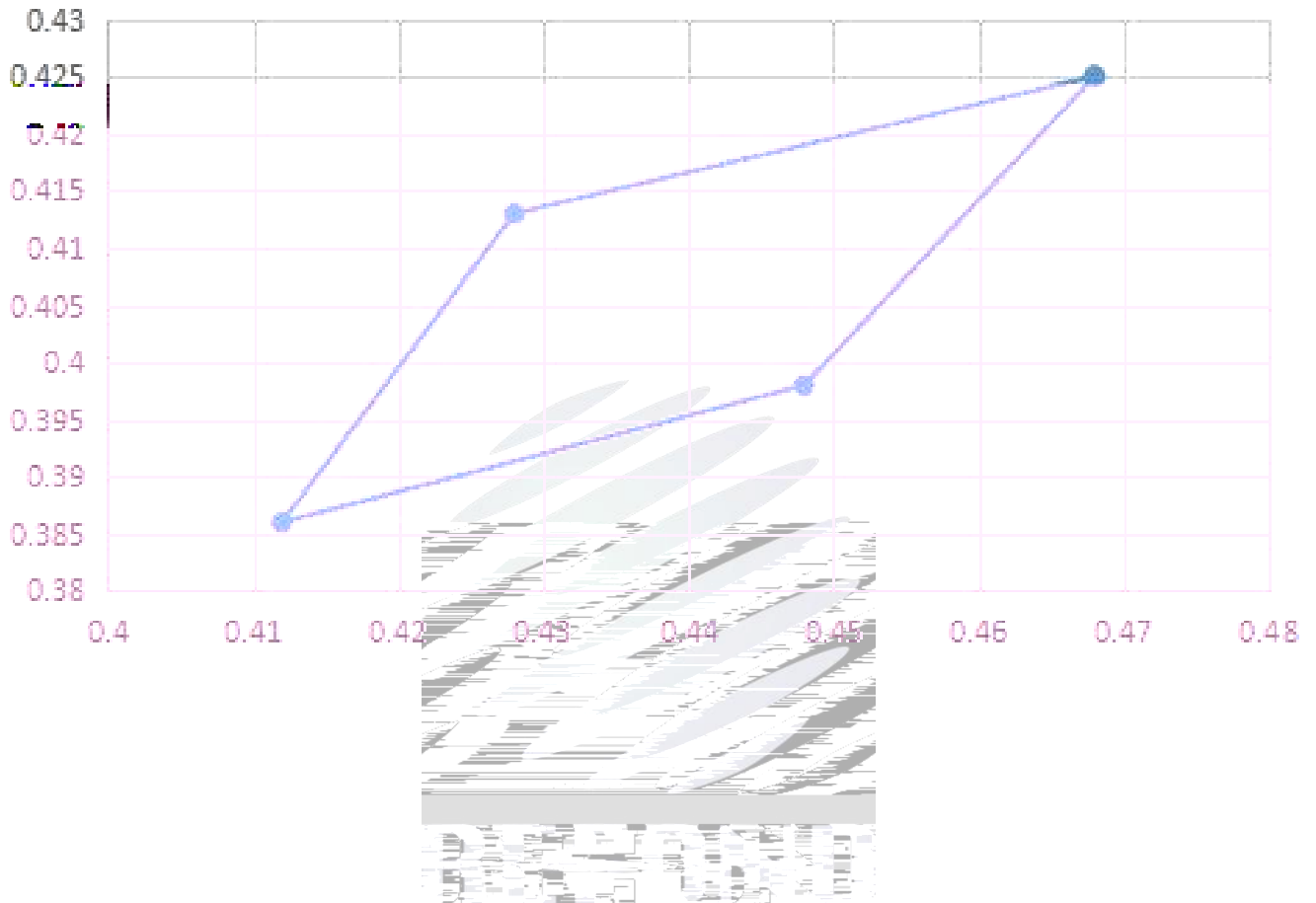

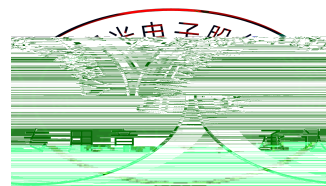

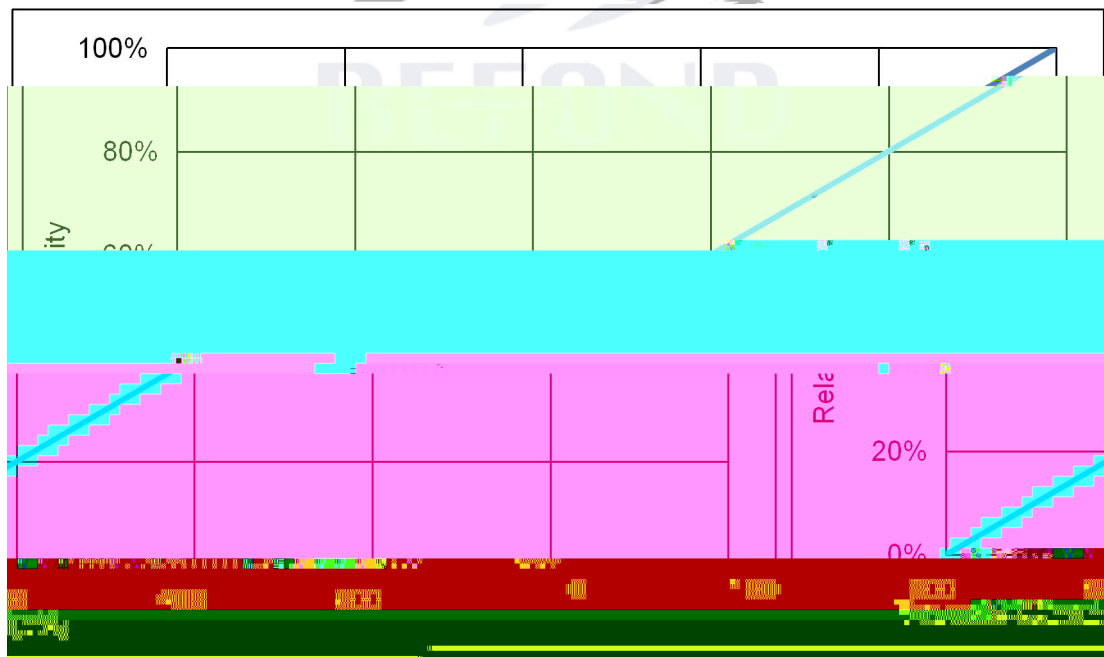
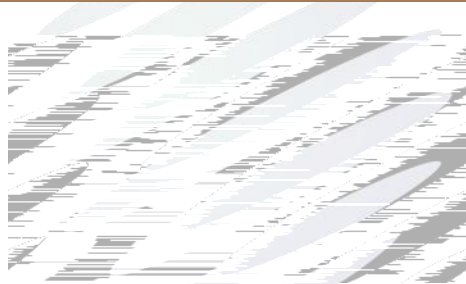
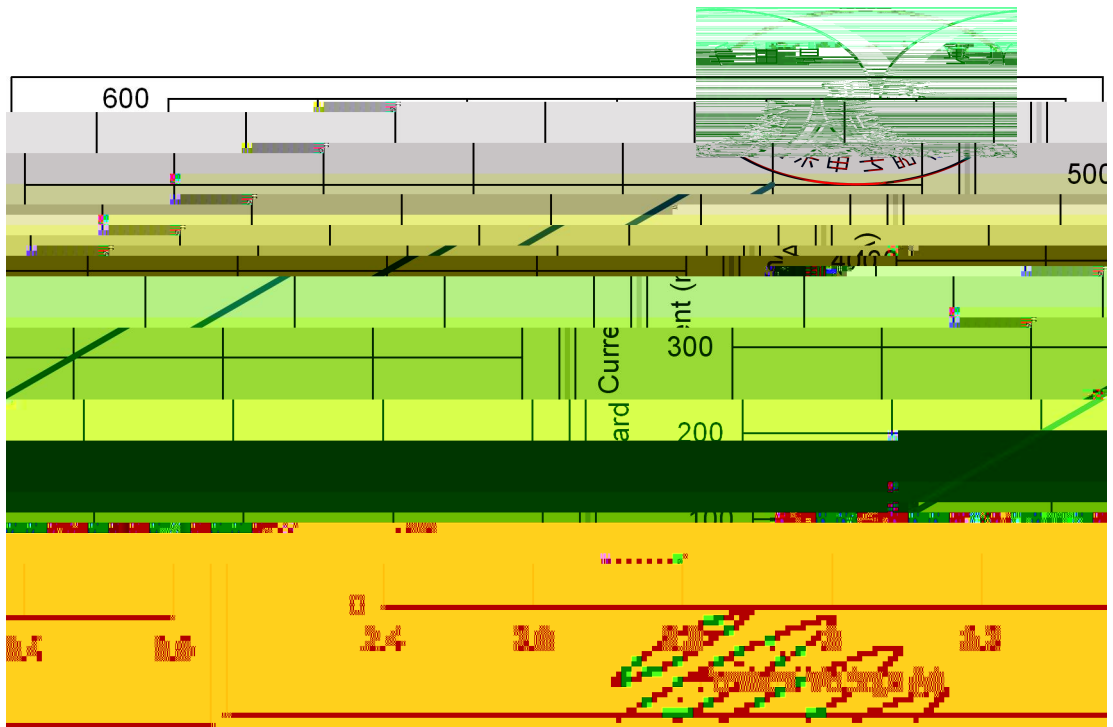

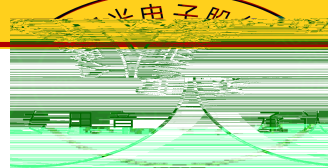
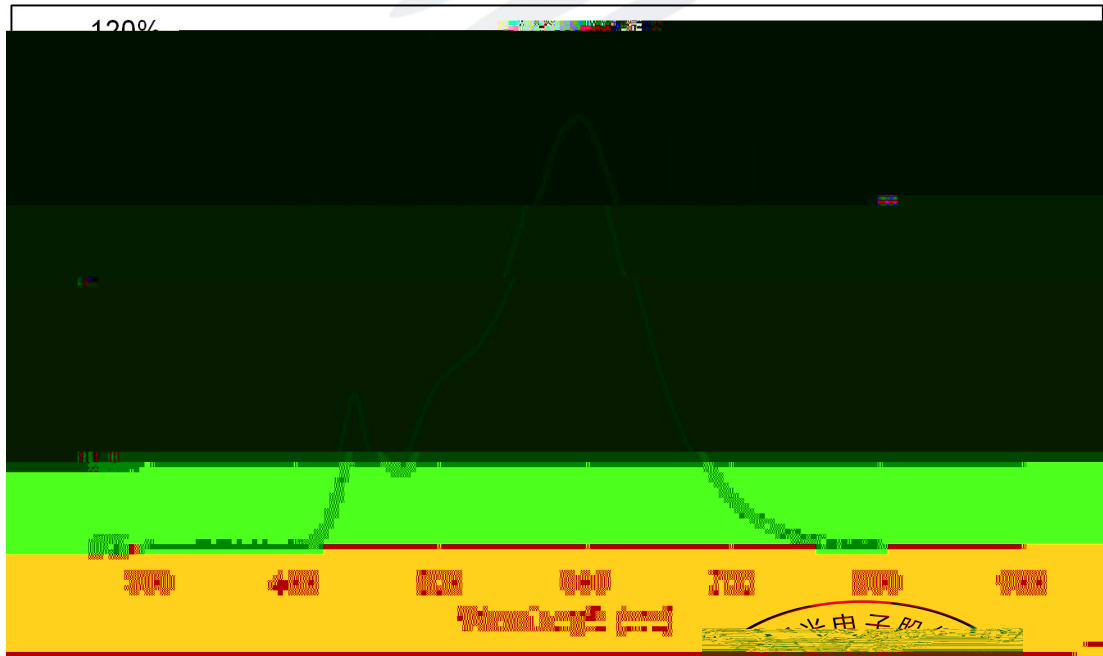
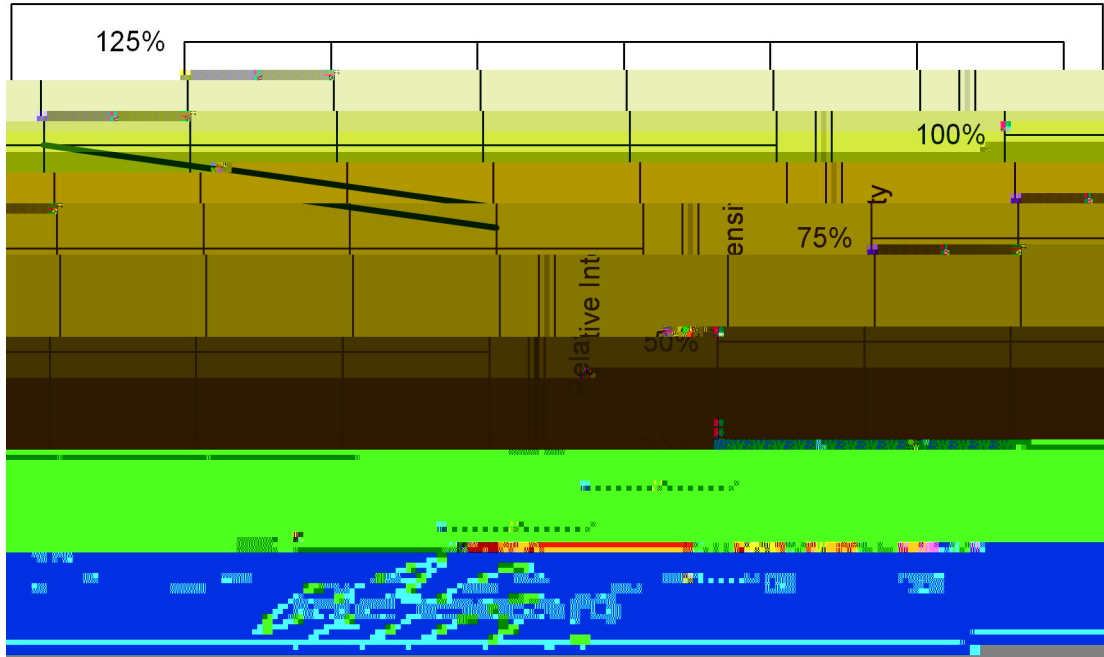

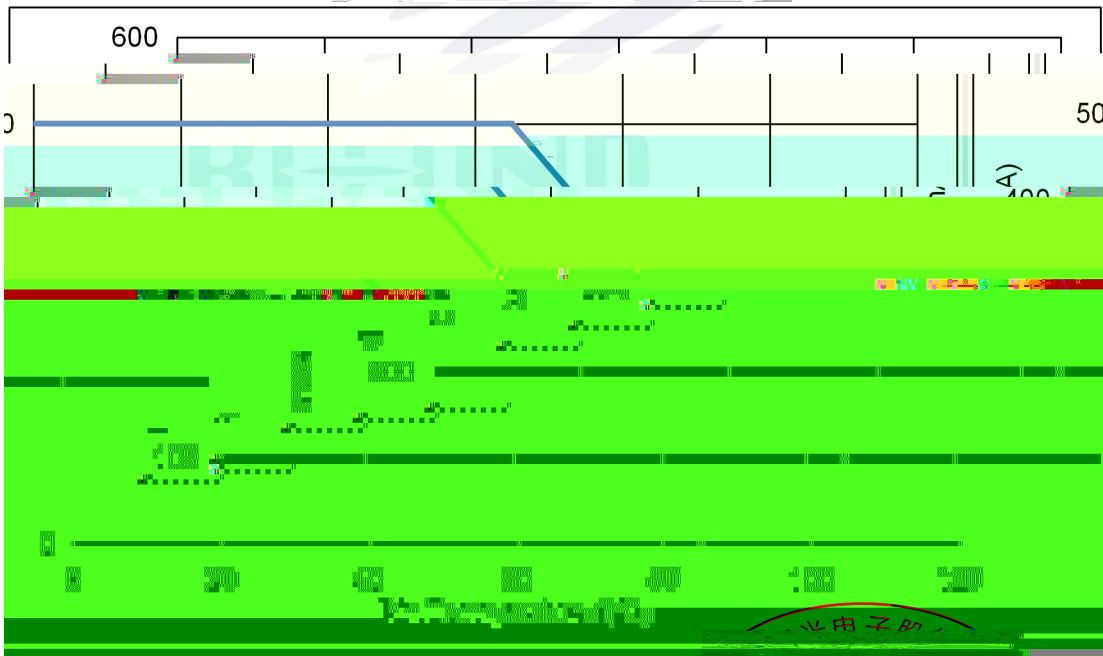
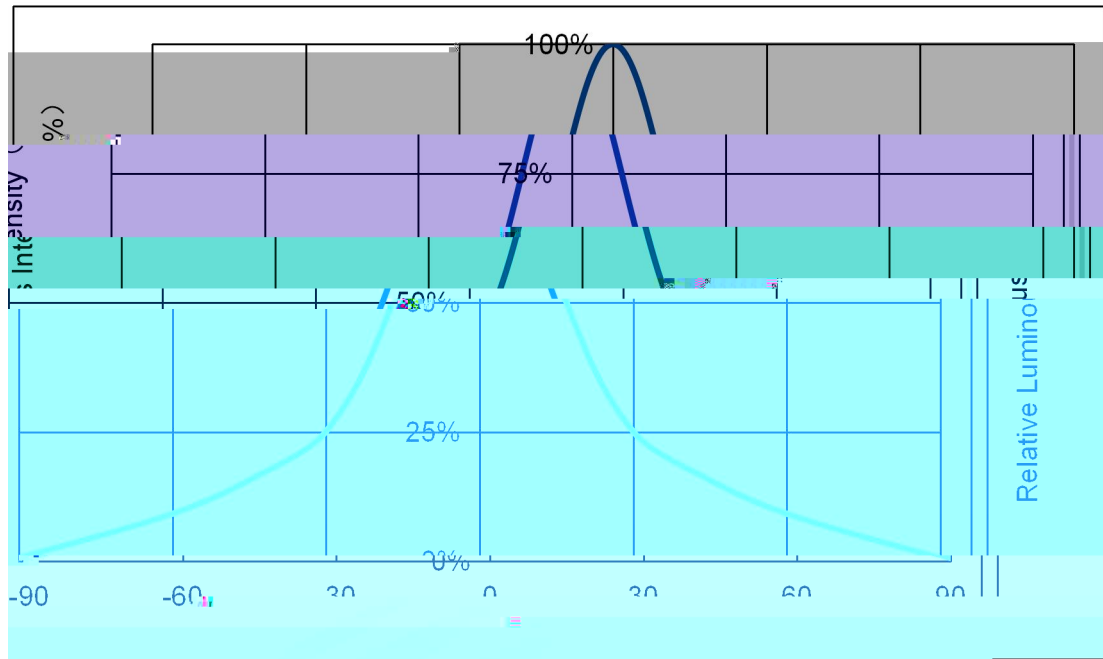

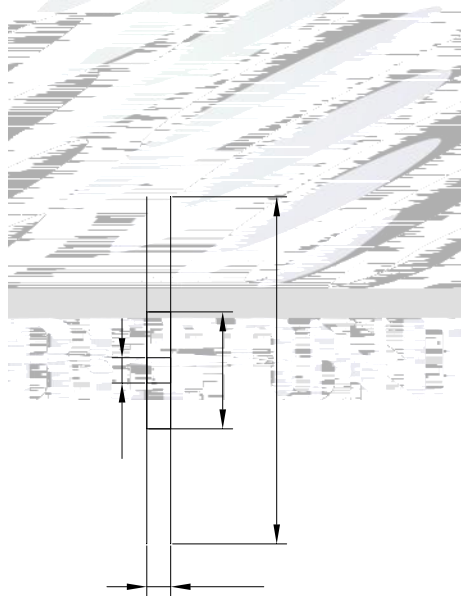
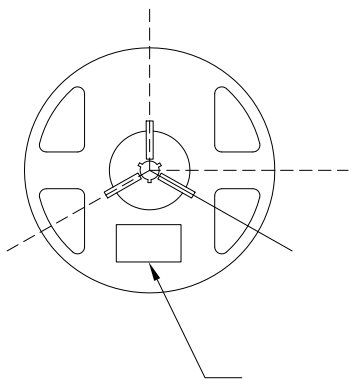
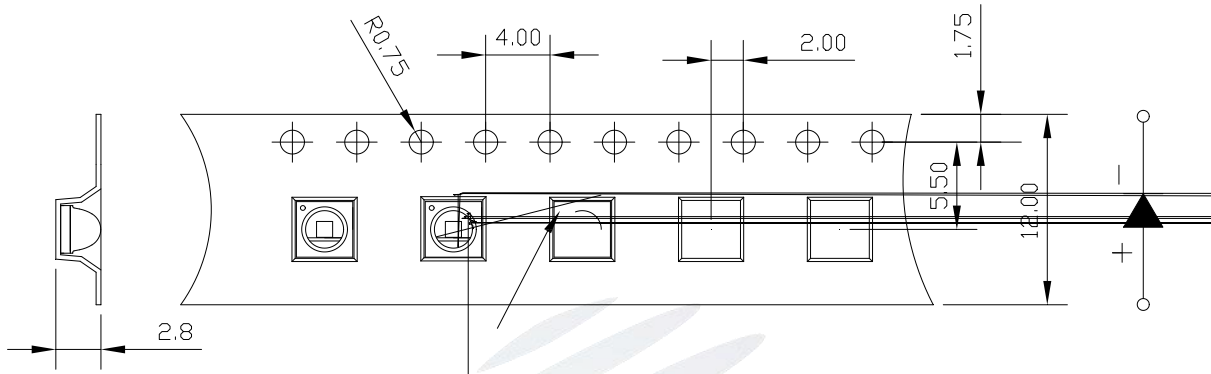

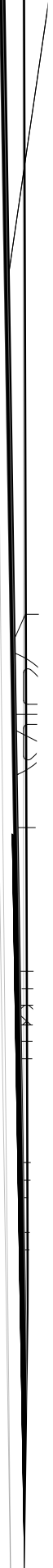

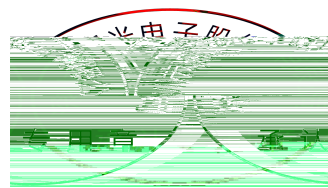

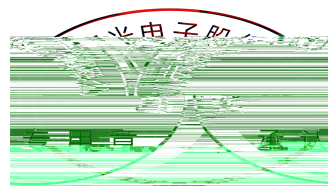



瑞豐

信託

信託理財



信託理財



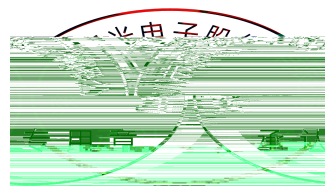

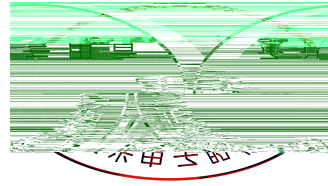



±

