

1.

1.1

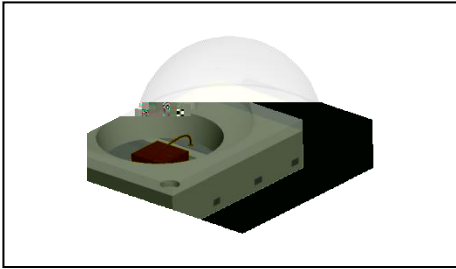

1.2

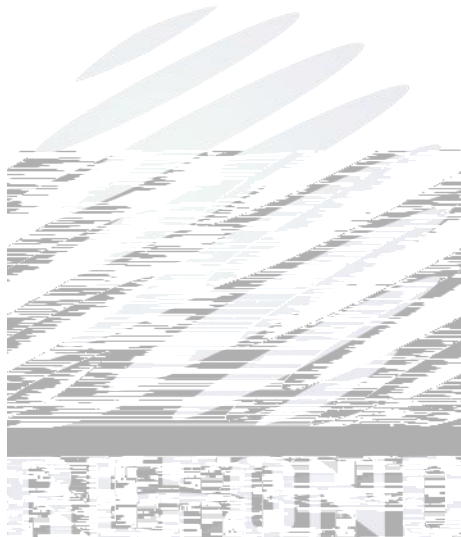

1.

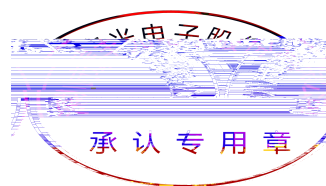

1.

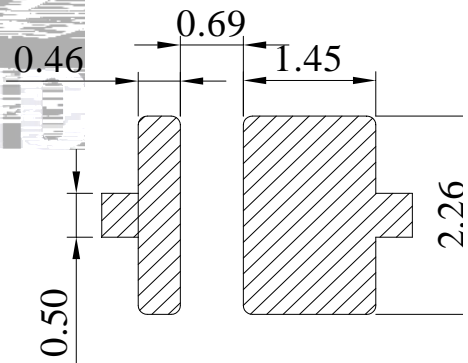
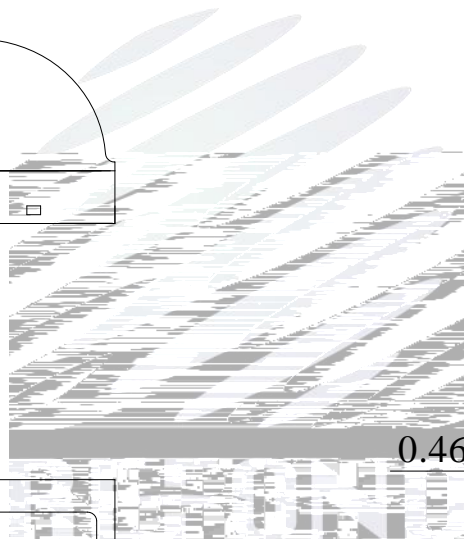
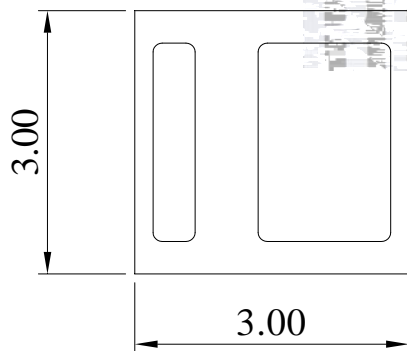
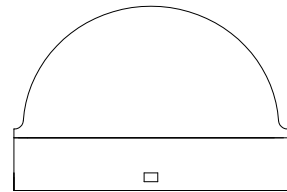
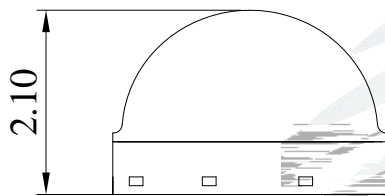
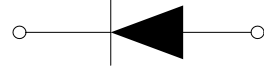
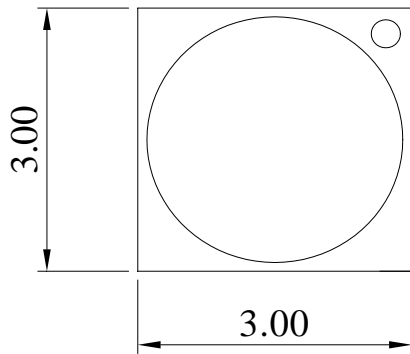

±

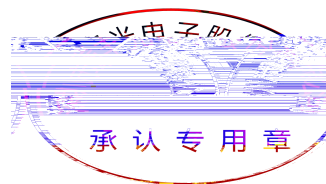

1.

	λ					

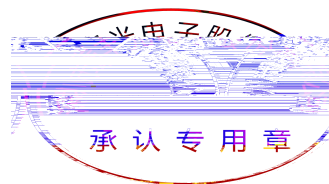

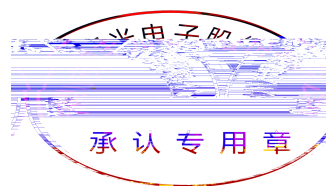
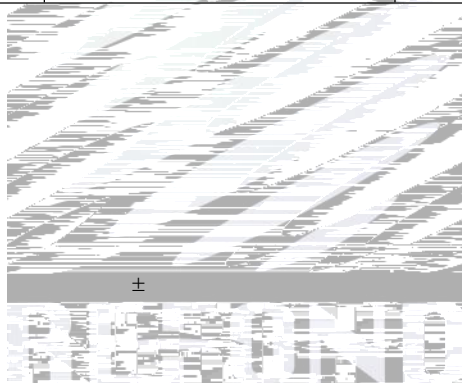

1.

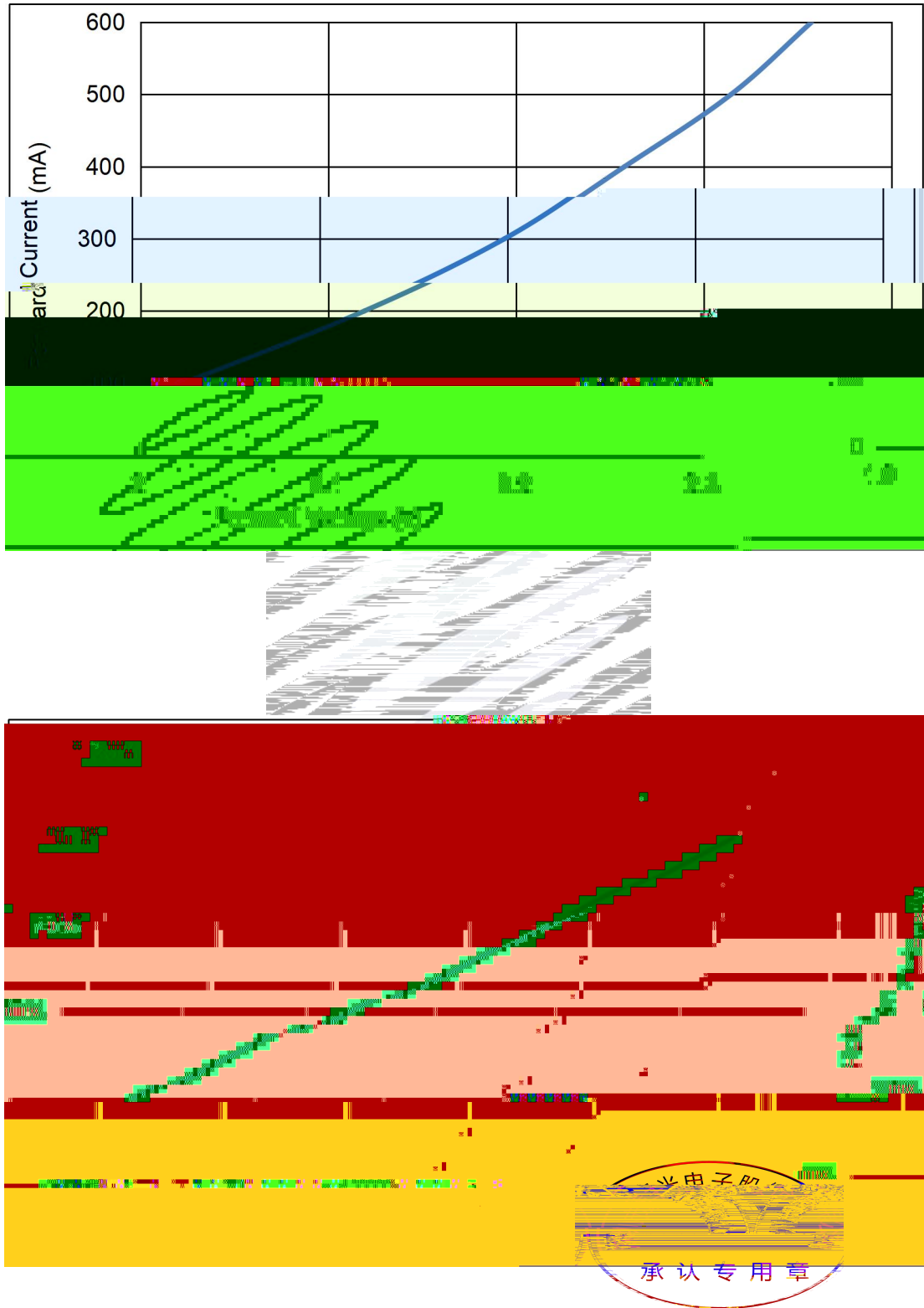

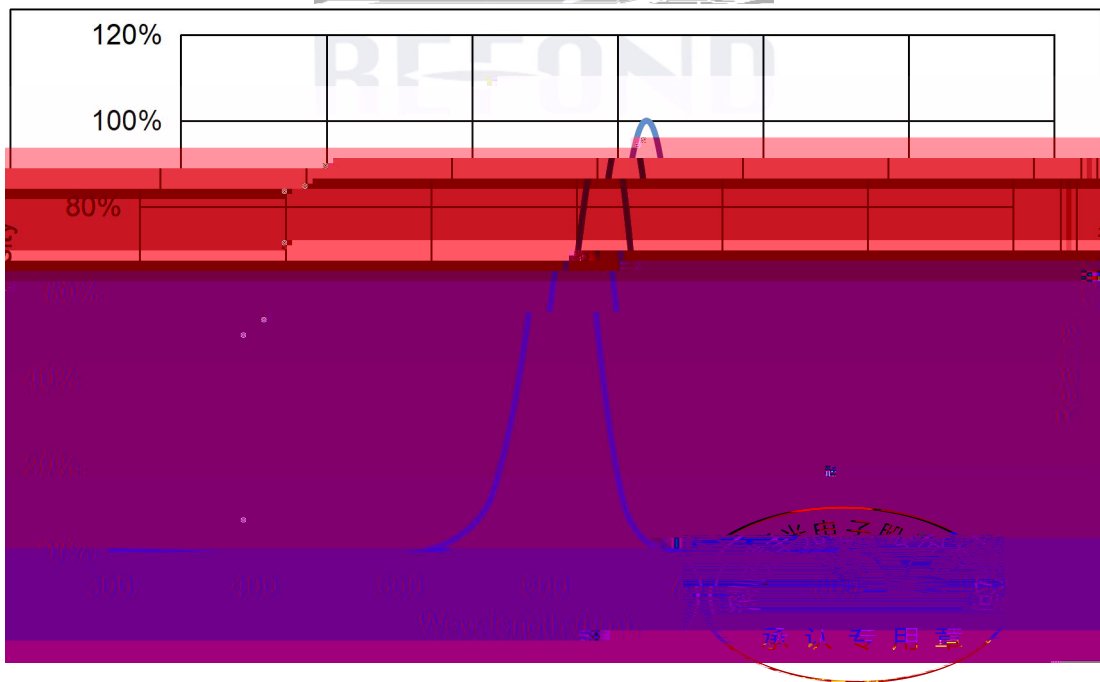
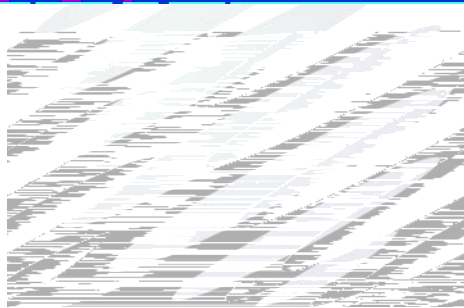
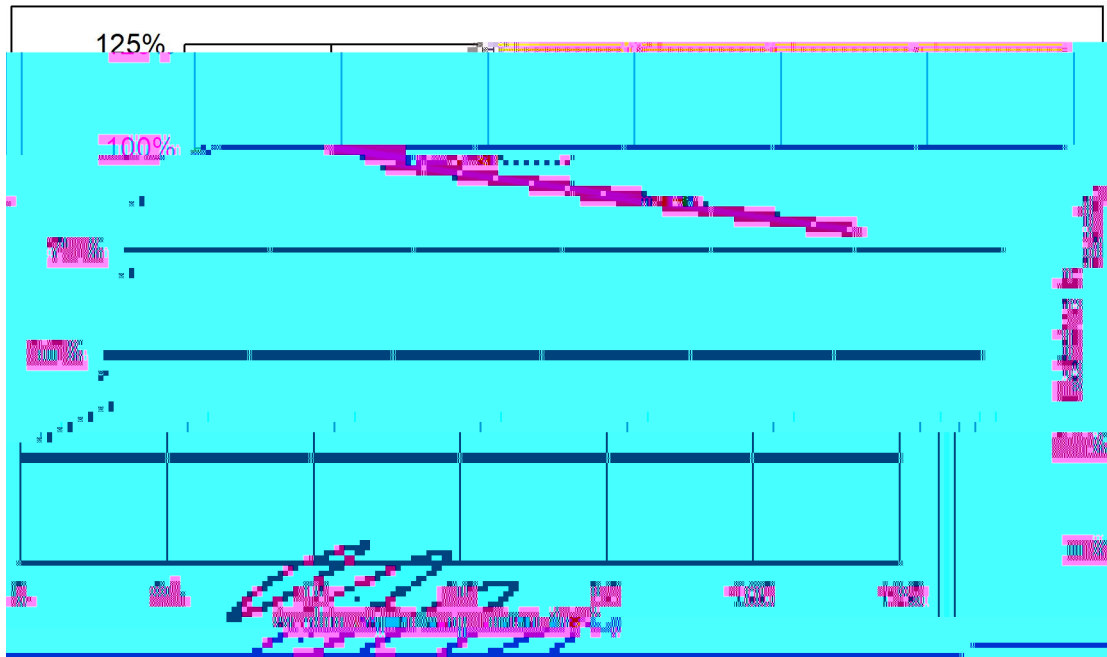

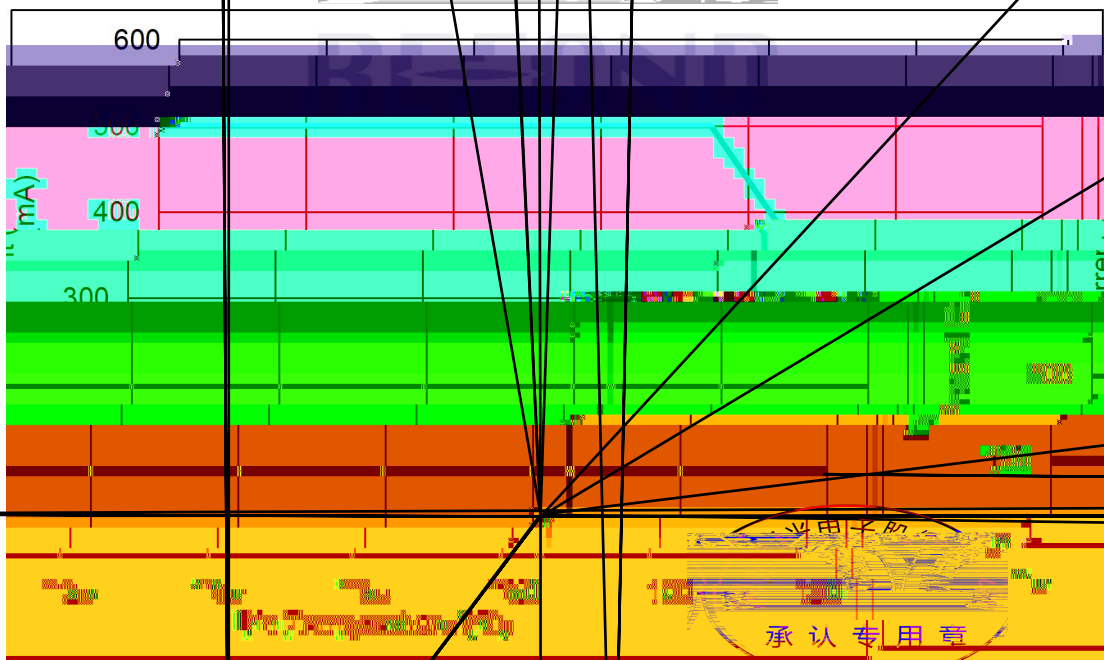
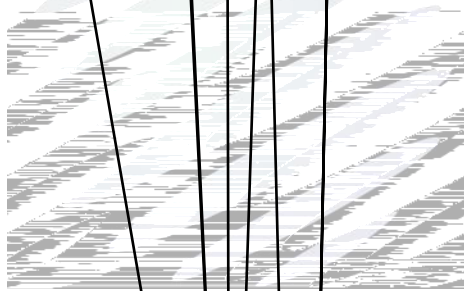
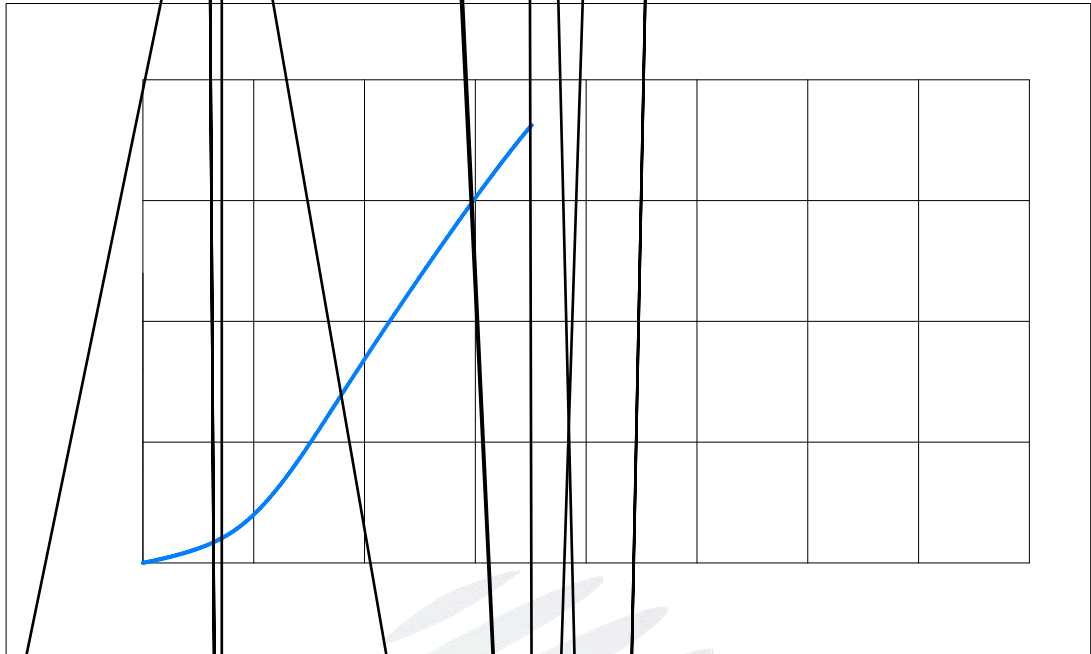

2.

2.1

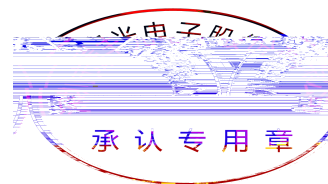
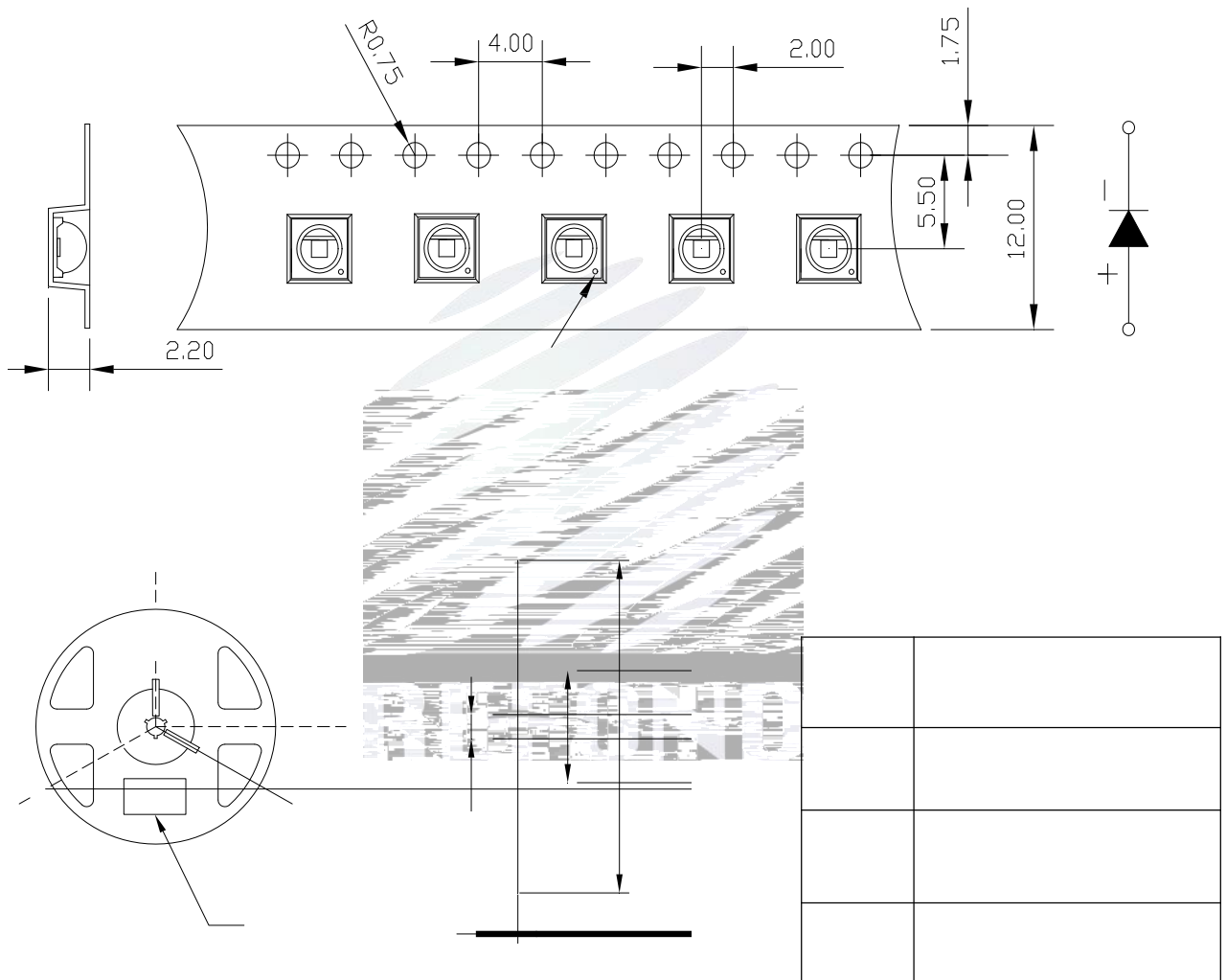



001-110051-SABU11E

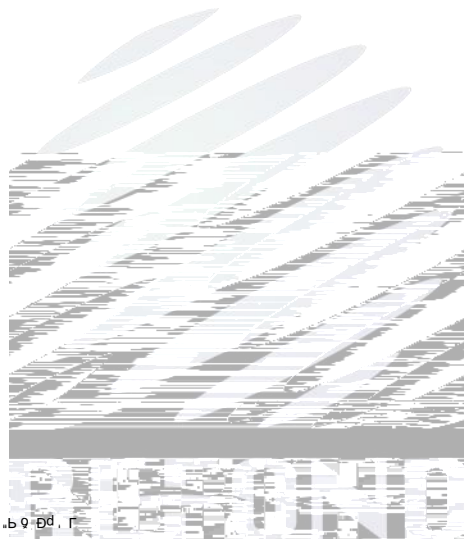

ТДУГГ \-П-Г 001-110051-SABU11E н.9 @ПБ ED .Б9-ED .Г

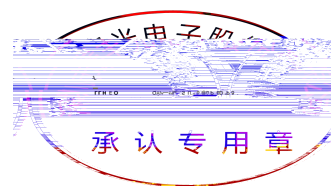

2.

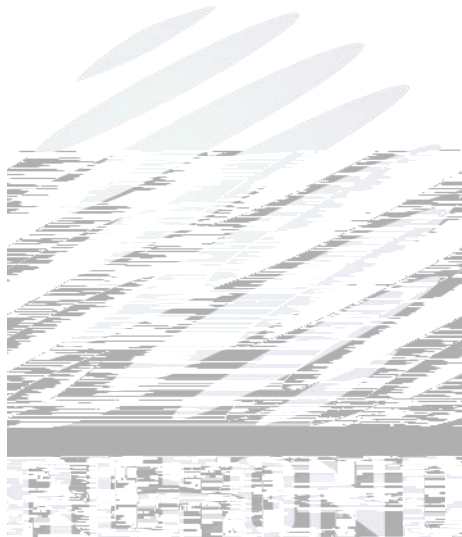

2.

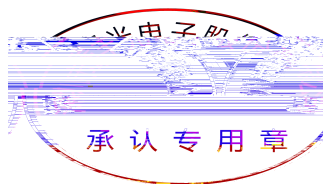
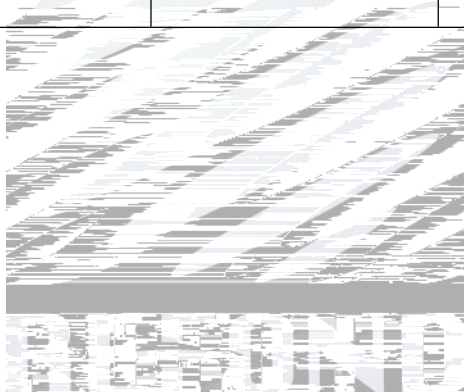

R

%

G %L*(¢ ypÒÈje! ^ ,ò @ù P 62•0`
R' V

L

BDUQJ '@W! B ypÒK@N± , '@ J÷, Úâ ‡,° \$ _N±... ,° @Rj pñ



'BXEN

'B01' ΓHK

IE H

H DH iM>i - ' ' zhifv. BC A#9

DB

MA

BC HXOC

Γ

: GXPH 0% ' 7÷ ' ' 0 bnyv. ‡ xeyloCO ‡— 0Di. Eλ s λb0e i λ. zc ••



.1

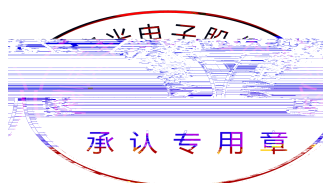
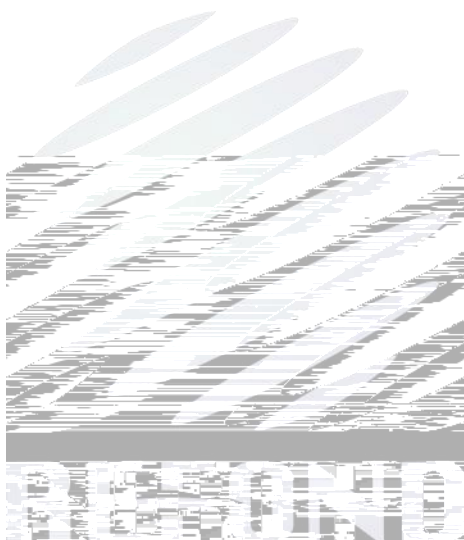

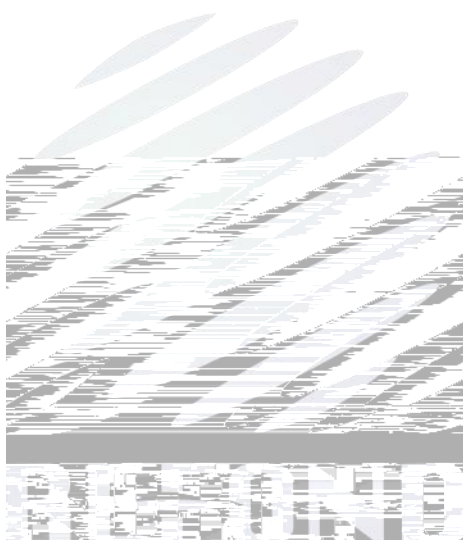
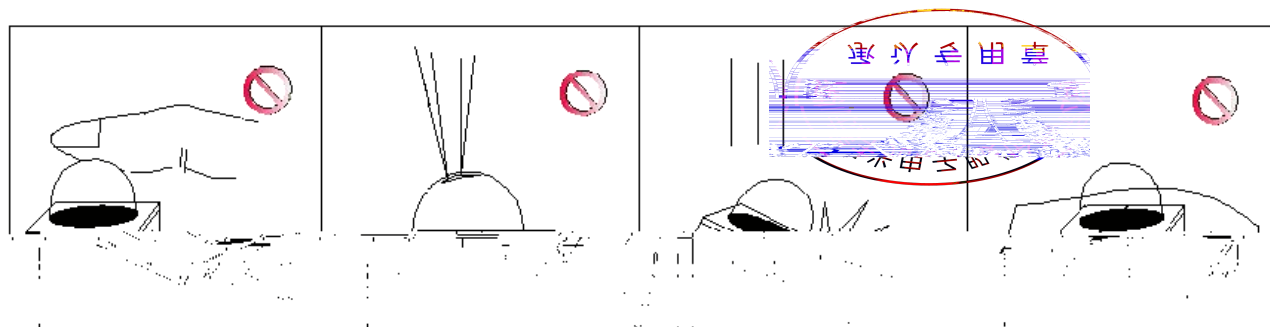

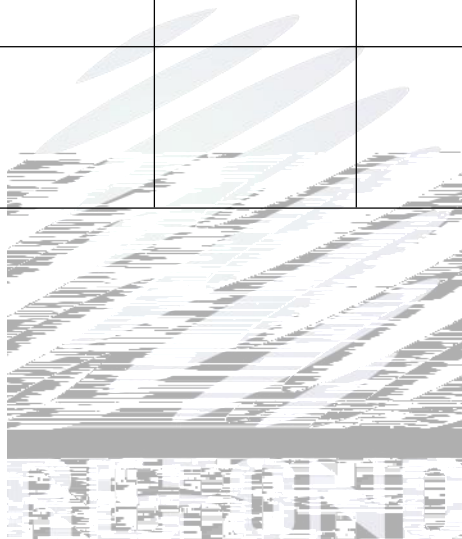

±

