



Contents

1. Description	
1.1 General Description	
1.2 Features	
1.3 Application	
1.4 Package Dimension	
1.5 Product Parameters	
1.6 Bin Range Of Forward Voltage and Luminous Intensity (IF=5mA)	BIN
(IF=5mA)	
1.7 Typical Optical Characteristics Curves	
2. Packaging	
2.1 Packaging Specification	
2.1.1 Carrier Tape Dimension	12
2.1.2 Reel Dimension	12
2.1.3 Label Form Specification	13
2.2 Moisture Resistant Packing	
2.3 Cardboard Box	
2.4 Reliability Test Items And Conditions	
2.5 Criteria For Judging Damage	
3. SMT Reflow Soldering Instructions SMT	
3.1 SMT Reflow Soldering Instructions SMT	
4. Handling Precautions	
4.1 Handling Precautions	



1. Description

1.1

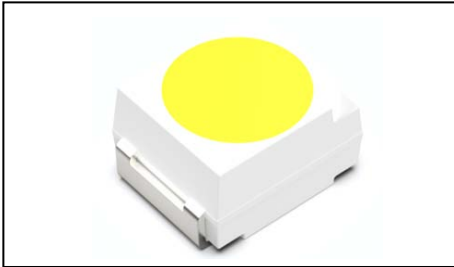

The White LED, which was fabricated by using a blue chip and the phosphor.

Product Package:3.50mmX2.80mmX1.84mm.

LED

3.50mmX2.80mmX1.84mm.

1.2 Features

PLCC2 Package. PLCC2

Extremely wide viewing angle.

Suitable for all SMT assembly and solder process. SMT

Available on tape and reel.

Moisture sensitivity level: Level 2. Level2

Compliance with RoHS and REACH. 符合RoHS和REACH要求

Qualifications: The product qualification test plan is based on the guidelines of AEC-Q101 Stress Test Qualification for Automotive Grade Discrete Semiconductors

AEC-Q101

1.3 Application

Automotive Interior Lighting. 汽 内 照明

Switches. 开关



1.4 Package Dimension

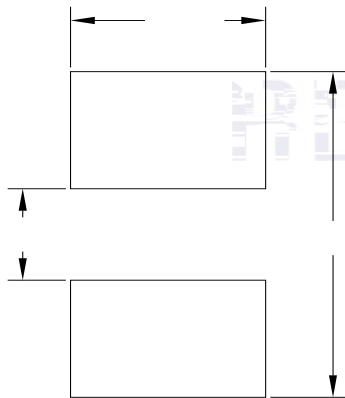
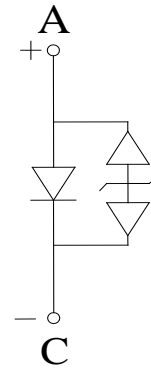
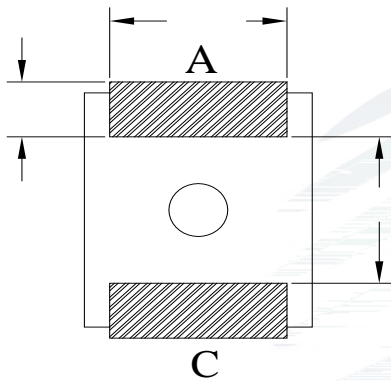
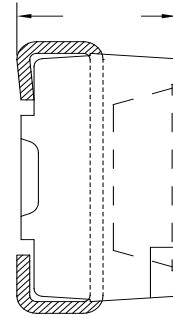
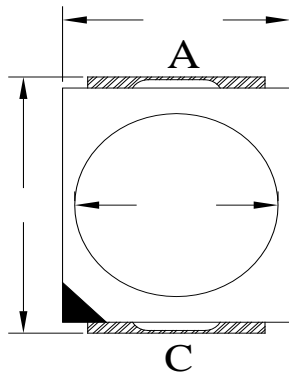

Notes

1. All dimensions units are millimeters.
2. All dimensions tolerances are $\pm 0.2\text{mm}$ unless otherwise noted.



1.5 Product Parameters

Table 1-1 Electrical / Optical Characteristics at Ts=25°C

Item	Symbol	Test Condition	Value			Unit
			Min.	Typ.	Max.	
Forward Voltage	V_F	$I_F=5mA$	2.5	2.7	3.1	V
Reverse Current	I_R	$V_R=5V$	---	---	10	μA
Luminous Intensity	I_V	$I_F=5mA$	350	480	650	mcd
Viewing Angle		$I_F=5mA$	---	120	---	deg
Thermal Resistance.	R_{THJ-S}	$I_F=5mA$	---	---	300	/W

Table 1-2 Absolute Maximum Ratings at Ts=25°C

Parameter	Symbol	Rating	Units
Power Dissipation	P_D	91	mW
Forward Current	I_F	30	mA
Peak Forward Current	I_{FP}	100	mA
Reverse Voltage	V_R	5	V
Electrostatic Discharge (HBM)	E_{SD}	8000	V
Operating Temperature	T_{OPR}	-40 ~ +100	
Storage Temperature	T_{STG}	-40 ~ +100	
Junction Temperature	T_J	120	

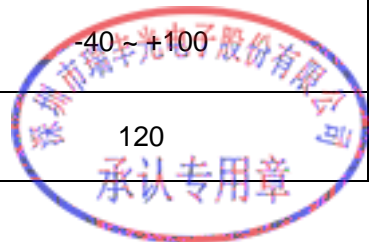



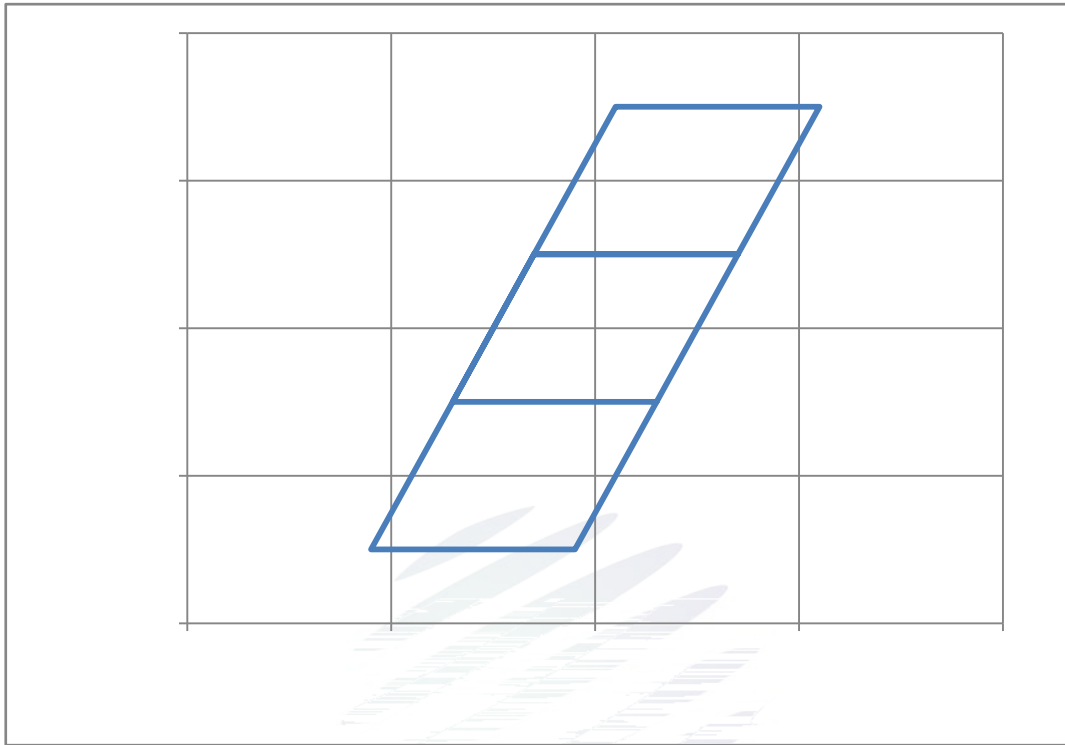

Fig. 1-6 The C.I.E Chromaticity Diagram CIE

Table 1-4

BIN CODE	CIE-X1	CIE-Y1	CIE-X2	CIE-Y2	CIE-X3	CIE-Y3	CIE-X4	CIE-Y4
L01	0.2090	0.1950	0.2130	0.2050	0.2230	0.2050	0.2190	0.1950
L02	0.2130	0.2050	0.2170	0.2150	0.2270	0.2150	0.2230	0.2050
L03	0.2170	0.2150	0.2210	0.2250	0.2310	0.2250	0.2270	0.2150



1.7 Typical Optical Characteristics Curves

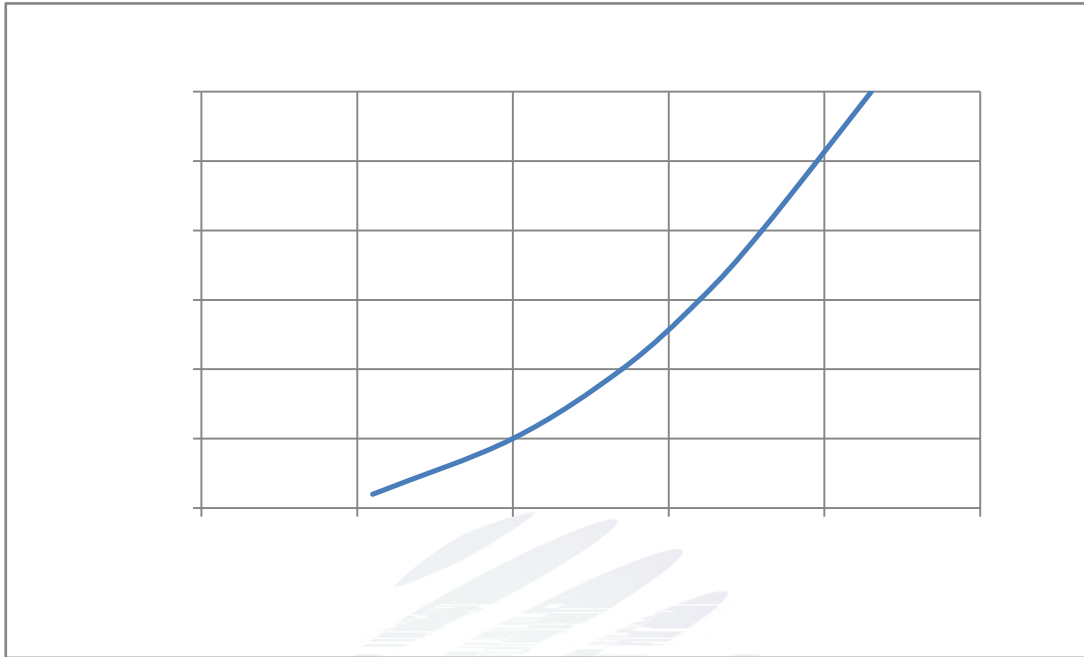

Fig. 1-7 Forward Voltage Vs Forward Current

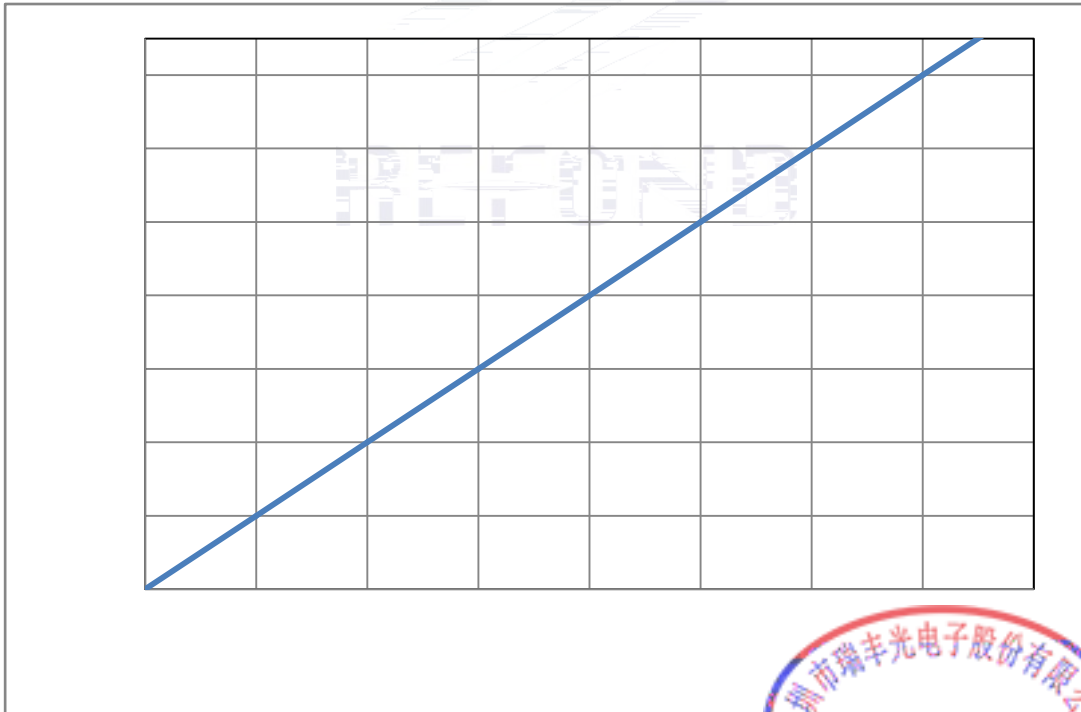
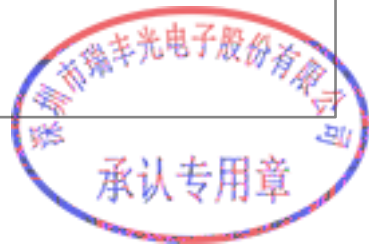

Fig. 1-8 Forward Current Vs Relative Intensity



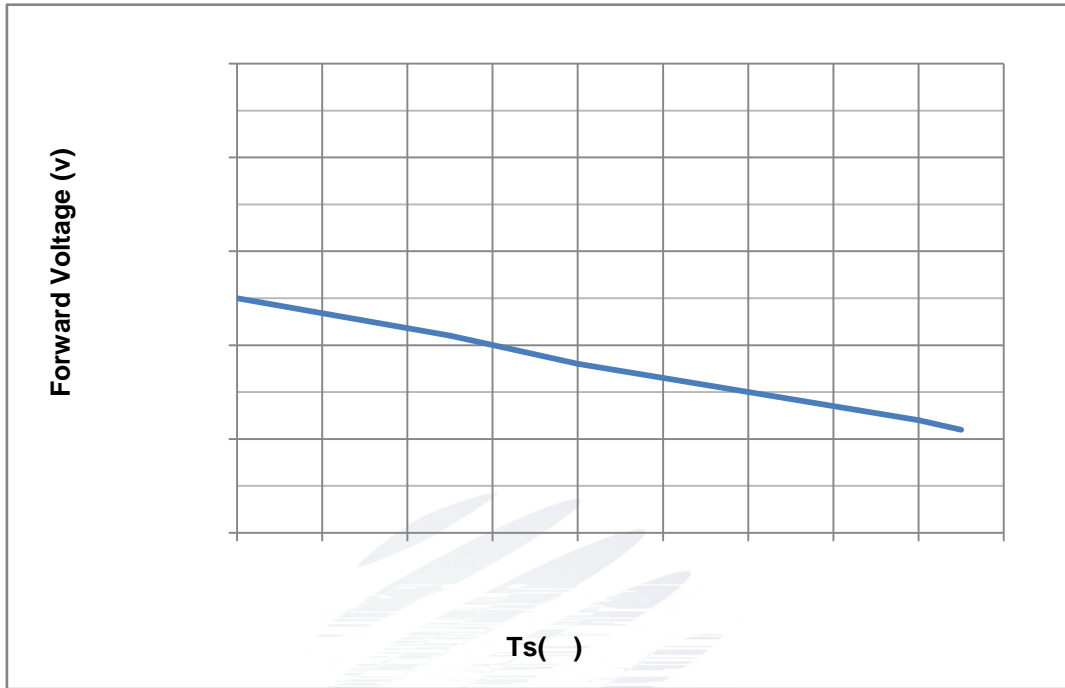

Fig. 1-11 Forward Voltage Vs Solder Temperature

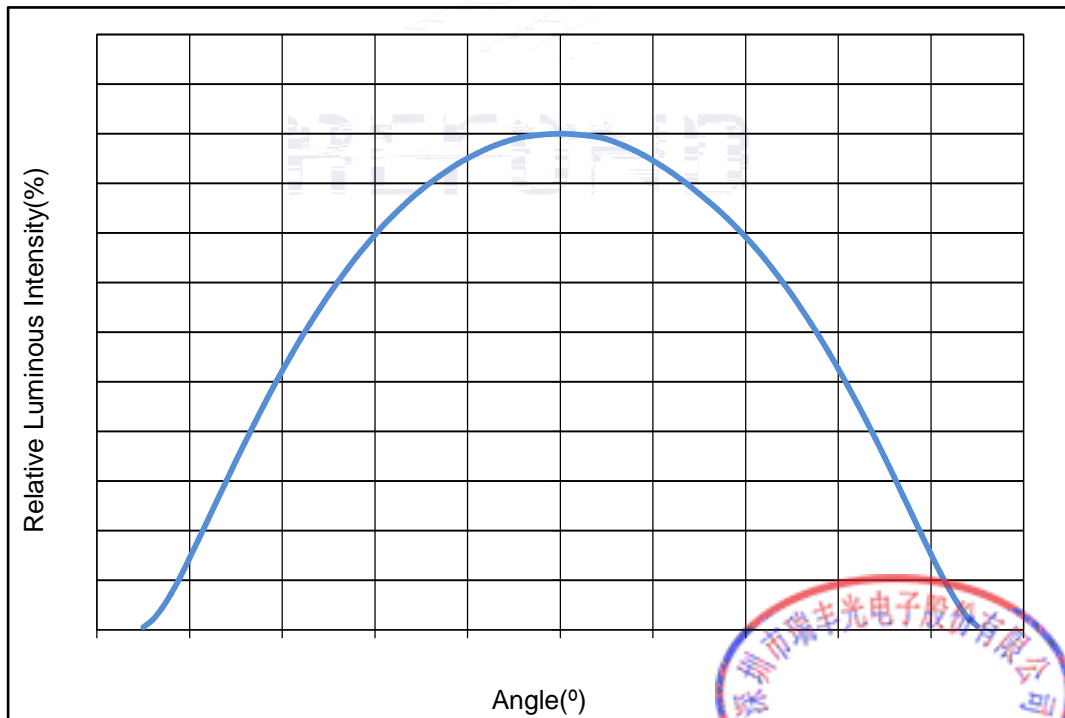
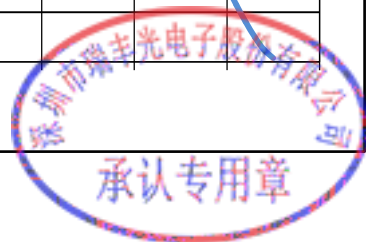

Fig. 1-12 Radiation diagram



2. Packaging



2.1.3 Label Form Specification

Table 2-2 Specification

PART NO.	Part Number
SPEC NO.	Spec Number
LOT NO.	Lot Number
BIN CODE	Bin Code
	Luminous flux
XY	Chromaticity Bin
V_F	Forward Voltage
WLD	Wavelength
QTY	Packing Quantity
DATE	Made Date

Fig. 2-3 Label Form Specification

2.2 Moisture Resistant Packing

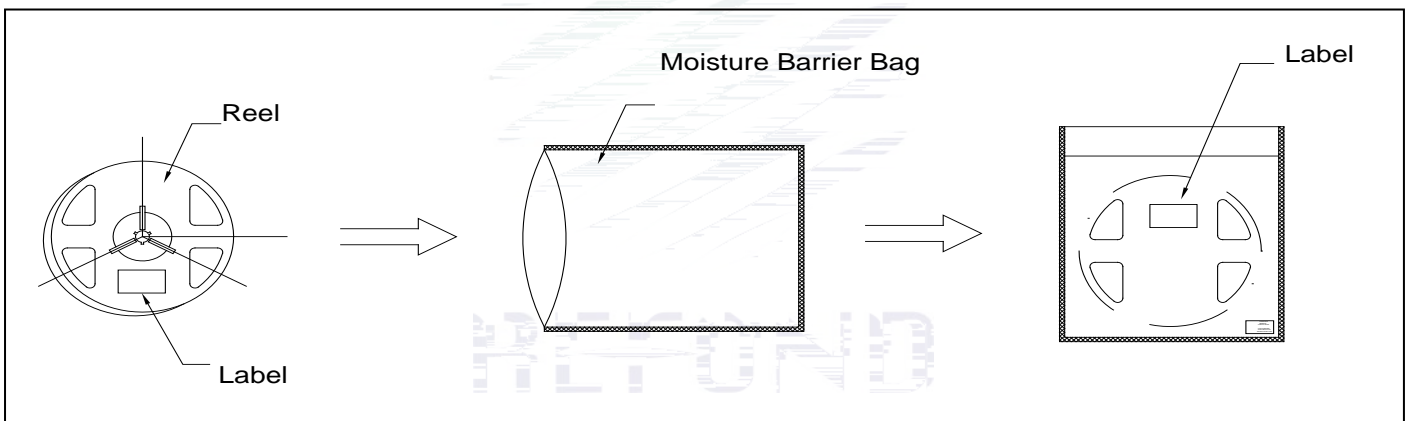

Fig.2-4 Moisture Resistant Packing

2.3 Cardboard Box

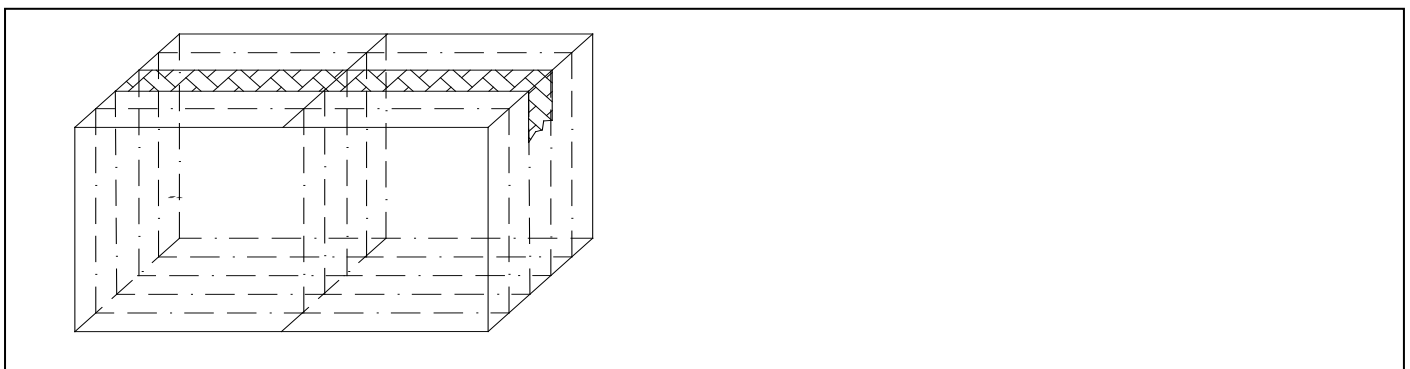

Fig.2- Cardboard Box

2.5 Criteria For Judging Damage

Table 2-4 Criteria For Judging Damage

Test Items	Symbol	Test Condition	Criteria For Judgement	
			Min.	Max.
Forward Voltage	V_F	$I_F=5mA$	-	U.S.L*)x1.1
Reverse Current	I_R	$V_R = 5V$	-	U.S.L*)x2.0
Luminous Flux		$I_F=5mA$	L.S.L*)x0.7	-

Notes

- 1.U.S.L: Upper standard level L.S.L: Lower standard level
- 2.The above reliability tests is based on the verification of a single/strip LED of Refond's existing experimental platform,the reliability experiment was taken under good heat dissipation conditions. when customers applies the LED to the series and parallel circuit, should take consideration of all the factors such as the current, voltage distribution, heat dissipation and others. / LED
LED
- 3.The technical information shown in the data sheets is limited to the typical characteristics and circuit examples of the referenced products. It does not constitute the warranting of industrial property nor the granting of any license.



3. SMT Reflow Soldering Instructions SMT 回流焊说明

3.1 SMT Reflow Soldering Instructions SMT

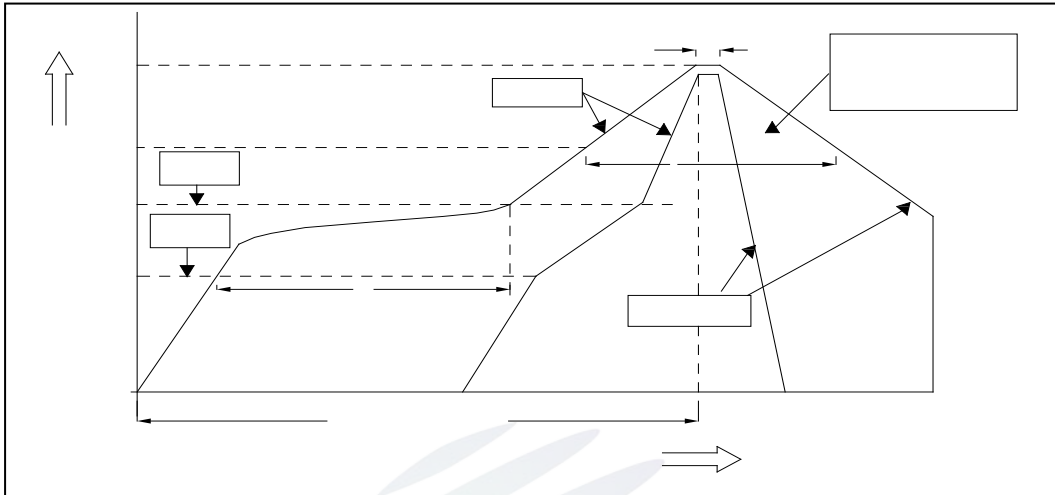
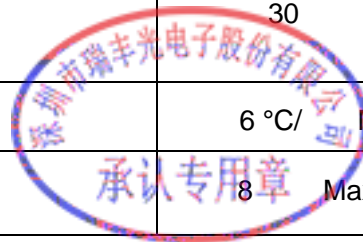

Fig.3-1 SMT Reflow Soldering Instructions SMT

Table 3-1 Reflow parameters

Average temperature rise speed	T_{smax}	T_P	3 °C/	Max 3 °C/ s
Preheating: minimum temperature	(T_{smin})		150 °C	
Preheating: Max temperature	(T_{smax})		200 °C	
Preheating: Time	T_{smin}	T_{smax}	60 - 120	60s-120s
Time limited to maintain high temperature: the temperature			(T_L)	217 °C
Time limited to maintain high temperature: The Time			(t_L)	60 Max 60s
Peak /Classification of temperature:	/	(T_P)	260 °C	
Time limit classification of peak temperature time			t_p	10 Max 10s
(T_P) 5 °C	Hold time within 5 °C with the		30	Max 30s
actual peak temperature (TP)				
Cooling speed			6 °C/	Max 6 °C/ s
25 °C	Needed time from 25 °C to T_p		8	Max 8 minutes



Notes

(1)Reflow soldering should not be done more than twice. If more than 24 hours between the two solderings , LED will be damaged. 24 LED

(2)When soldering , do not put stress on the LEDs during heating.

3.1.1 Soldering Iron

(1) When do soldering by hand, keep the temperature of iron below less 300 less than 3 seconds. 300 3

(2) Soldering by hand should be done only one time.

3.1.2 Repairing

Repairing should not be done after the LEDs have been soldered. When repairing is unavoidable,a double-head soldering iron should be used (as below figure). It should be confirmed in advance whether the characteristics of LEDs will or not be damaged by repairing.

LED

LED

3.1.3 Cautions

(1) The encapsulated material of the LEDs is silicone. Therefore the LEDs have a soft surface on the top of package. The pressure to the top surface will be impacted on the reliability of the LEDs. Precautions should be taken to avoid the strong pressure on the encapsulated part. So when use the picking up nozzle, the pressure on the silicone resin should be proper. LED LED

(2) Components should not be mounted on warped (non coplanar) portion of PCB. After soldering, do not warp the circuit board.LED PCB

(3) Do not apply mechanical force or excess vibration during the cooling process to normal temperature after soldering. Do not rapidly cool device after soldering.

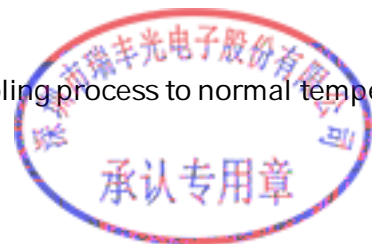

4. Handling Precautions

4.1 Handling Precautions

(1) LED operating environment and sulfur element composition cannot be over 100PPM in the LED mating usage material. This is provided for informational purposes only and is not a warranty or endorsement.

LED 100PPM

(2) In order to prevent external material from getting into the inside of LED, which may cause the malfunction of LED, the single content of Bromine element is required to be less than 900PPM, the single content of Chlorine element is required to be less than 900PPM, the total content of Bromine element and Chlorine element in the external materials of the application products is required to be less than 1500PPM. This is provided for informational purposes only and is not a warranty or endorsement.

LED 900PPM LED 900PPM LED 1500PPM

(3) VOCs (Volatile organic compounds) emitted from materials used in the construction of fixtures can penetrate silicone encapsulants of LEDs and discolor when exposed to heat and photonic energy. The result can be a significant loss of light output from the fixture. Knowledge of the properties of the materials selected to be used in the construction of fixtures can help prevent these issues. Refond advises against the use of any chemicals or materials that have been found or are suspected to have an adverse affect on device performance or reliability. To verify compatibility, Refond recommends that all chemicals and materials be tested in the specific application and environment for which they are intended to be used. Attaching LEDs, do not use adhesives that outgas organic vapor.

LED LED LED

(4) Handle the component along the side surface by using forceps or appropriate tools; Do not directly touch or Handle the silicone lens surface, it may damage the internal circuitry.



Fig 4-1 Handling Precautions

(5) In designing a circuit, the current through each LED can not be



Table 4-1 Storage

Conditions		Temperature	Humidity	Time
Storage	Before Opening Aluminum Bag	30	75%	Within 1 Year From Date
	After Opening Aluminum Bag	30	60%	Recommended for use within 24 hours
Baking		60± 5	-	24hours 24

(8) If the moisture absorbent material silica gel has faded away or the LEDs have exceeded the storage time, baking treatment should be performed after unpacking and based on the following condition 60± 5 for above 24 hours.

60± 5 24

If the package is flatulence or damaged, please notify the sales staff to assist.

(9) Similar to most Solid state devices; LEDs are sensitive to Electro-Static Discharge (ESD) and Electrical Over Stress (EOS). LED

(10) Other points for attention, please refer to our relevant information.



Date	Revisor	Version	Verifier	Remarks
2021/04/07	LI xianhui	E0	Zhu yiming	





www.refond.com

REFOND



Declare

This specification is written both in English and in Chinese and the latter is formal.