

SPECIFICATION

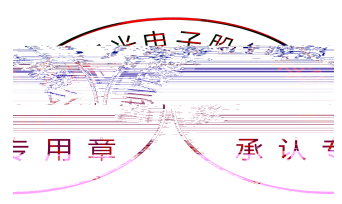

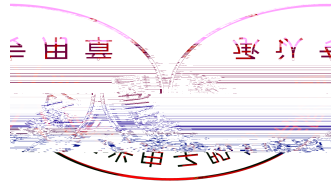

1. Description

1.1 General Description



1.2 Features



1.3 Application

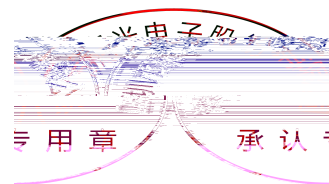

1.4 Package Dimension

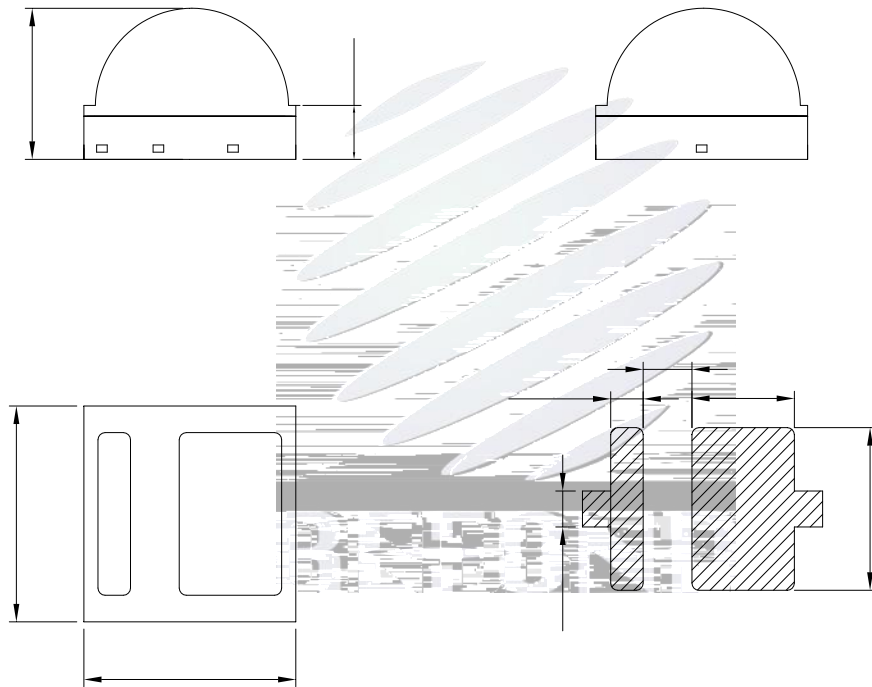
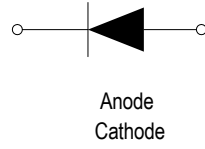
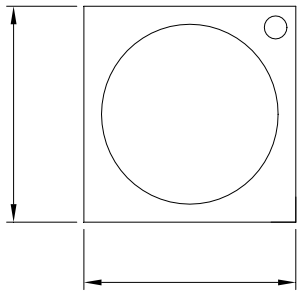

±

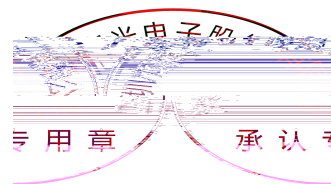

1.5 Product Parameters

	λ					

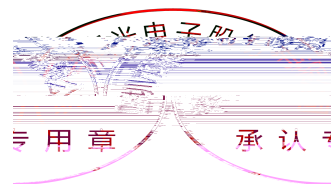
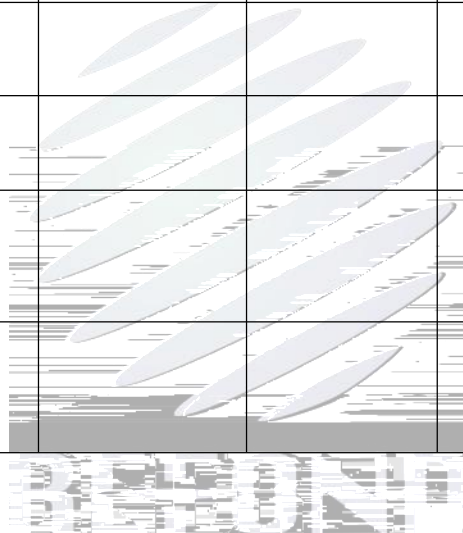



1.6 Typical optical characteristics curves

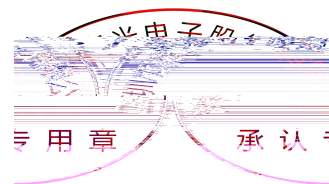
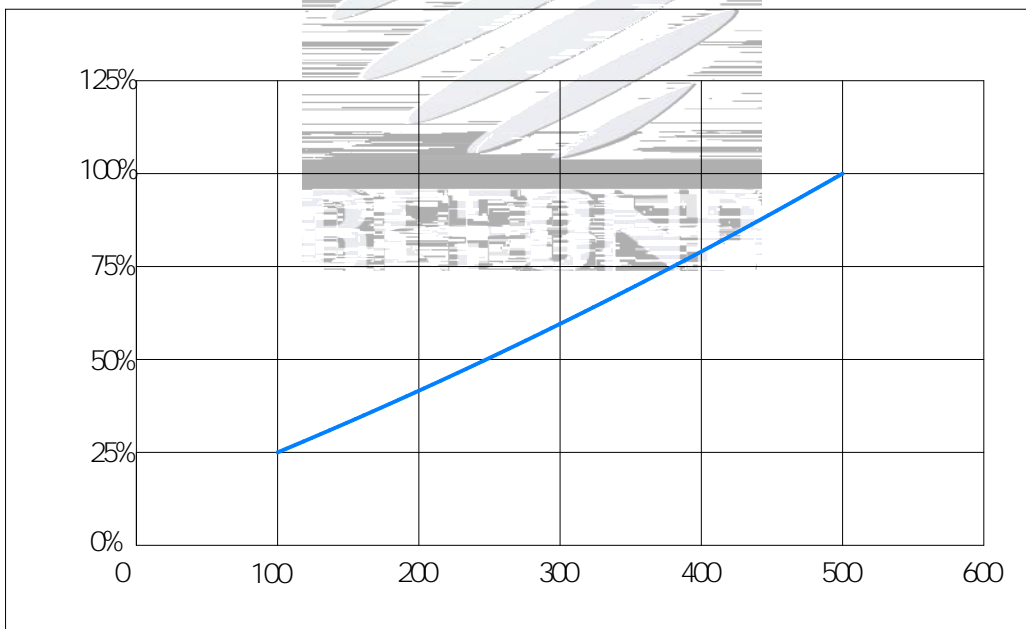
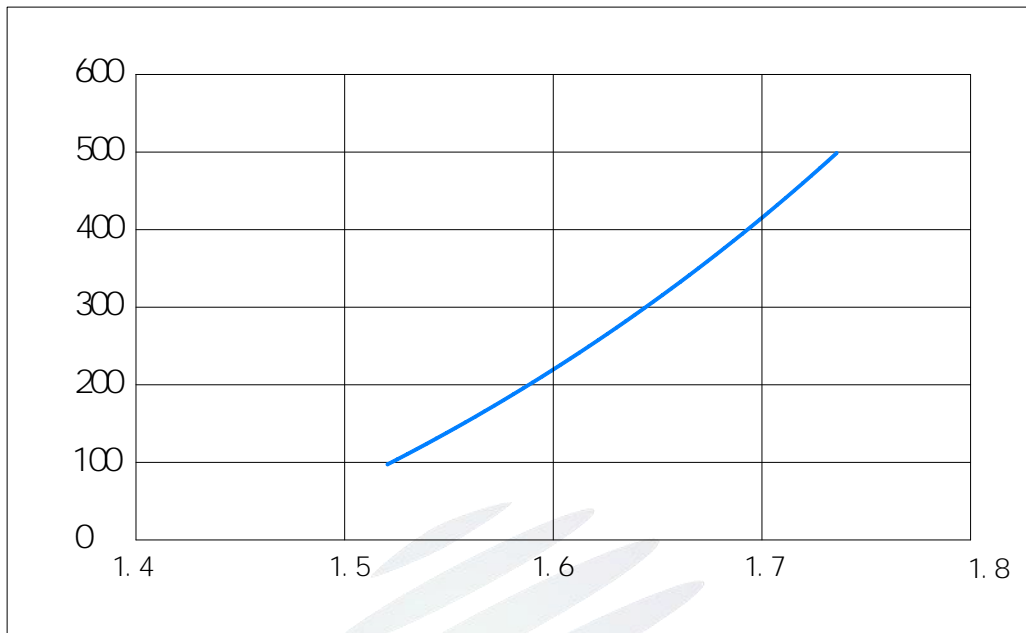

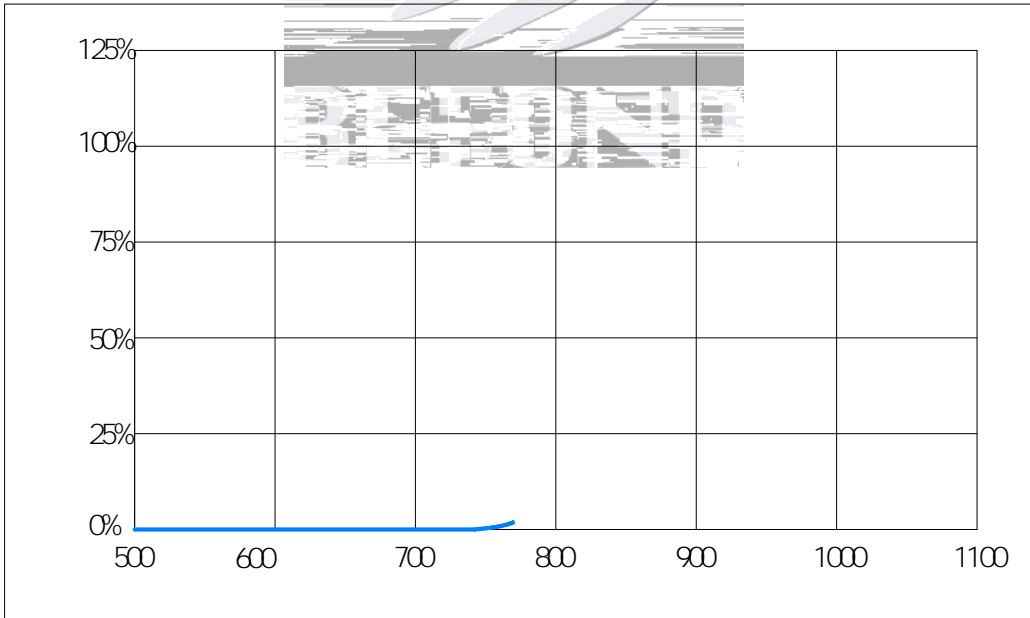
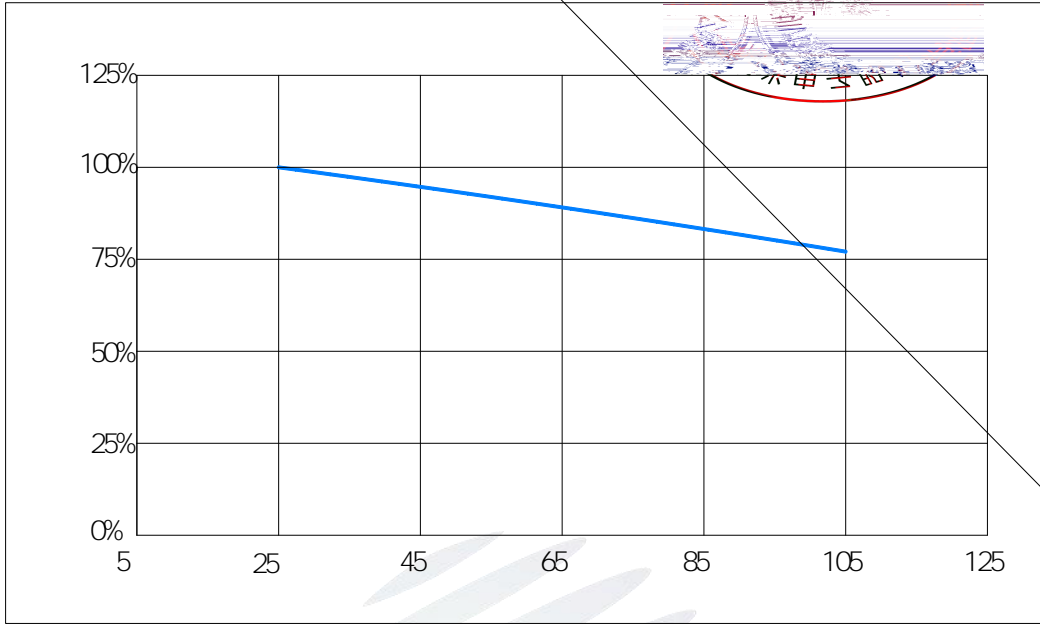
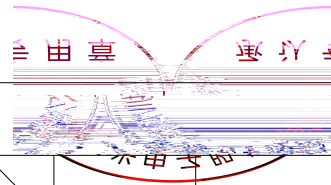

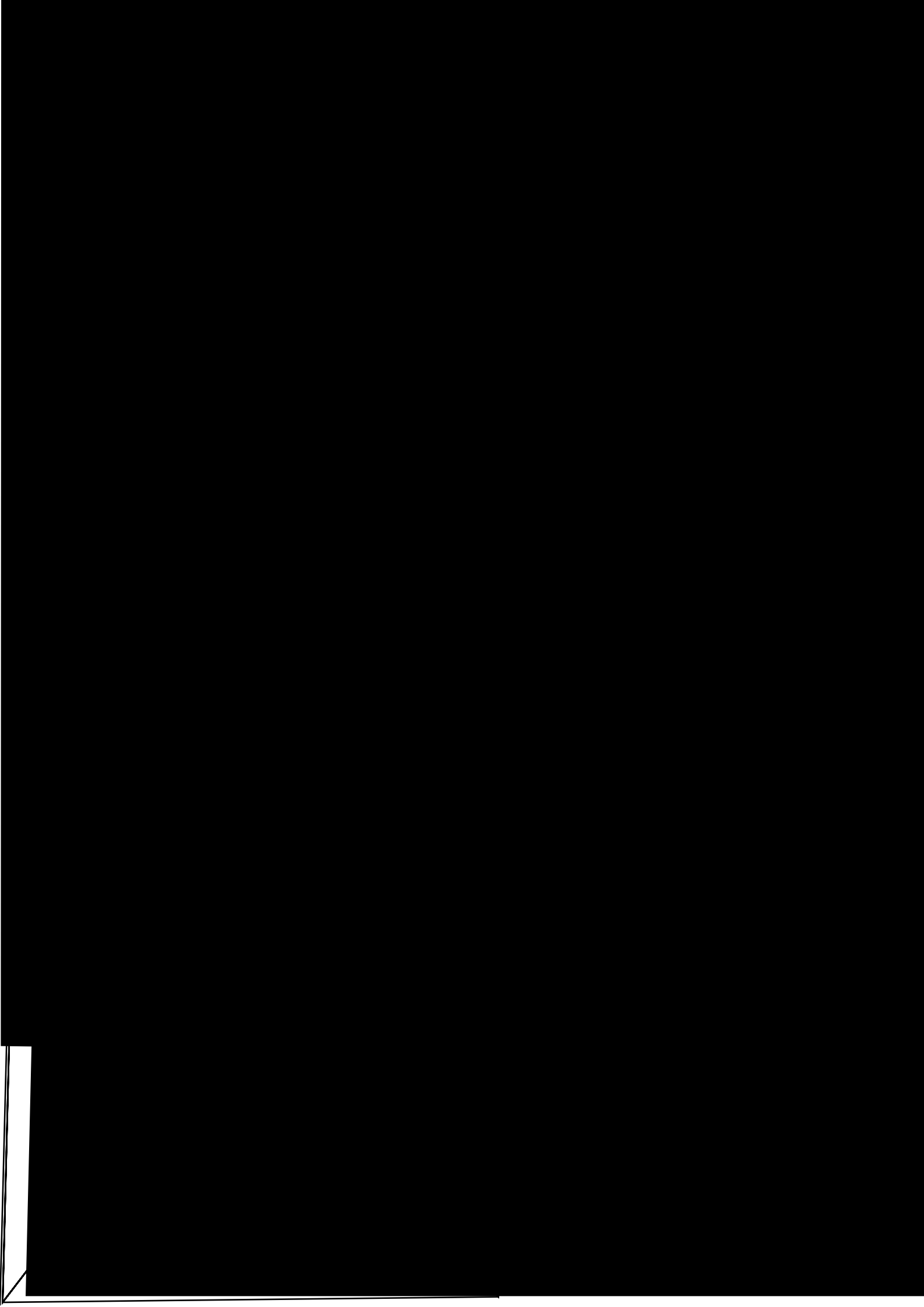

2. Packaging

2.1 Packaging Specification

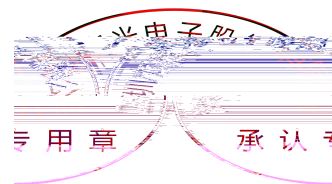
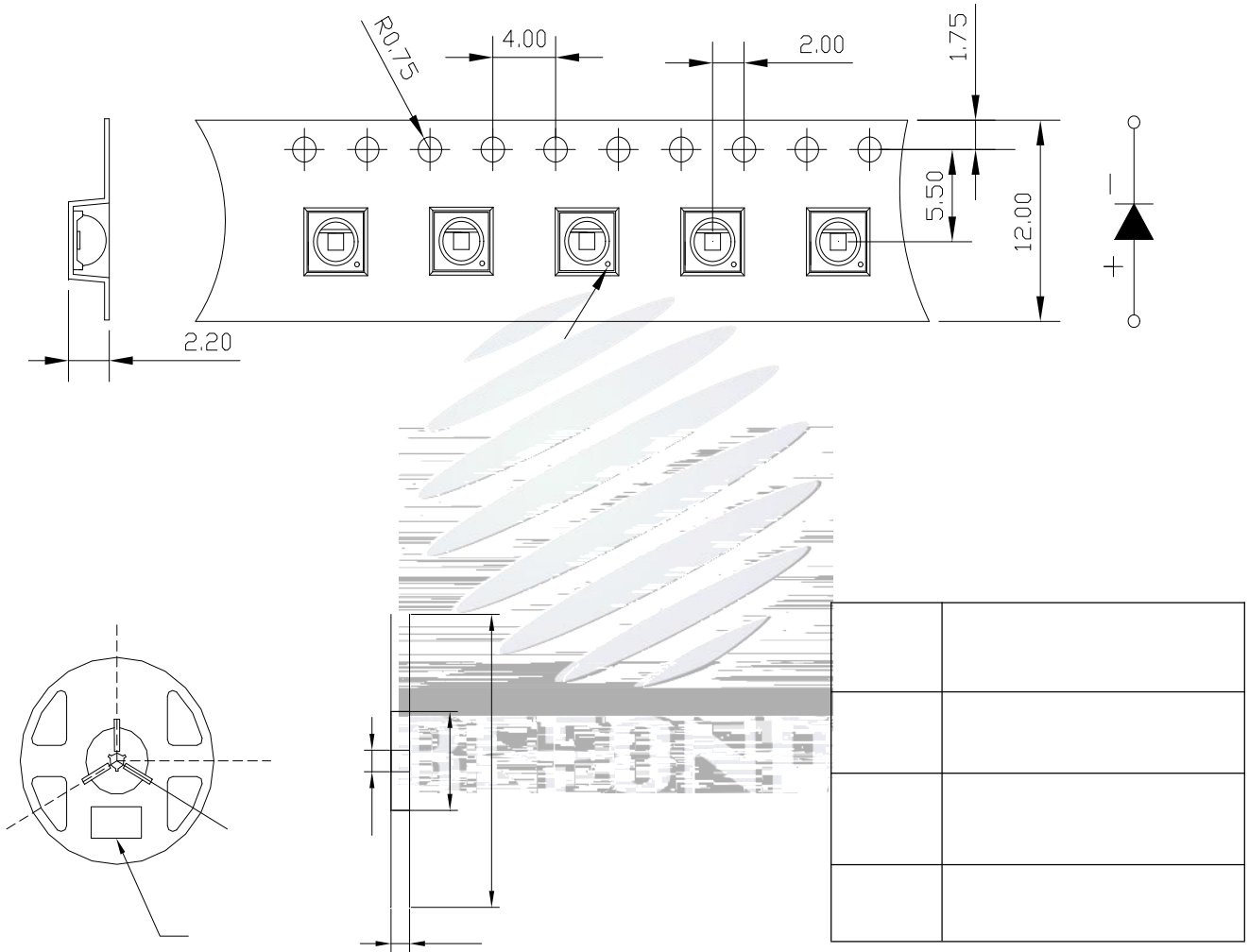

2.4 Reliability Test Items And Conditions

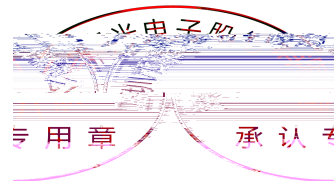

2.5 Criteria For Judging Damage

1.

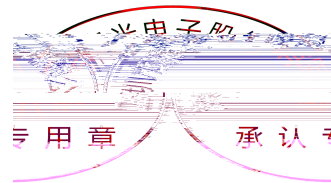

3. SMT Reflow Soldering Instructions

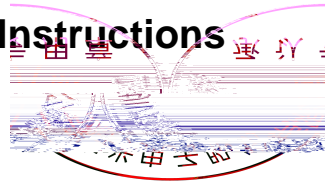

3.1 SMT Reflow Soldering Instructions



°C

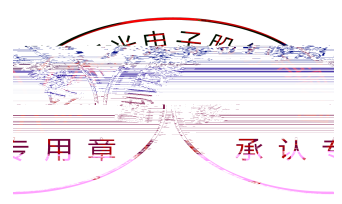

4. Handling Precautions

4.1 Handling Precautions

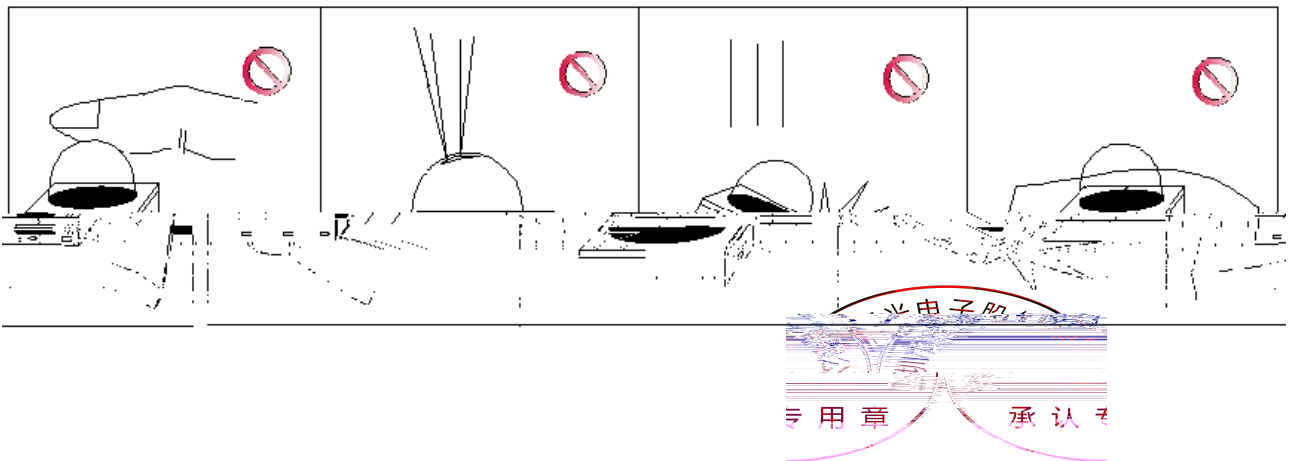

		±			

业册子助
专用章 承认

(7) () (±) °C

