

# SPECIFICATION

REFOND P/N

RF-A4E27-R15M-S6

R&D

Mass Production



# Contents

|   |     |
|---|-----|
| 1. Description  |     |
| 1.1 General Description                                       |     |
| 1.2 Features  |     |
| 1.3 Application   |     |
| 1.4 Package Dimension   |     |
| 1.5 Product Parameters  |     |
| 1.6 Bin Range Of Forward Voltage and Luminous Flux (IF=700mA) | BIN |
| (IF=700mA)  |     |
| 1.7 Typical Optical Characteristics Curves                    |     |
| 2. Packaging  |     |
| 2.1 Packaging Specification                                   |     |
| 2.1.1 Carrier Tape Dimension                                  | 11  |
| 2.1.2 Reel Dimension  | 11  |
| 2.1.3 Label Form Specification                                | 12  |
| 2.2 Moisture Resistant Packing                                |     |
| 2.3 Cardboard Box   |     |
| 2.4 Reliability Test Items And Conditions                     |     |
| 2.5 Criteria For Judging Damage                               |     |
| 3. SMT Reflow Soldering Instructions SMT                      |     |
| 3.1 SMT Reflow Soldering Instructions SMT                     |     |
| 4. Handling Precautions                                       |     |
| 4.1 Handling Precautions                                      |     |



## 1. Description

### 1.1 General Description

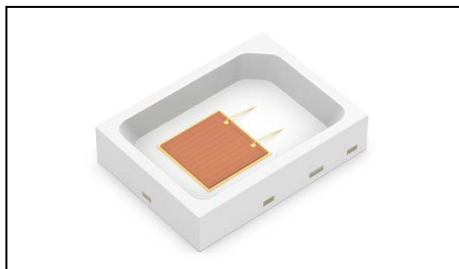

The red source color devices are made with AlGaInP on Substrate Light Emitting Diode .Product Package:2.7mmX2.0mmX0.6mm.

该红光 LED 由 AlGaInp 四种元素芯片激发而成，产品尺寸：2.7mmX2.0mmX0.6mm.

### 1.2 Features

EMC Package. EMC封装

Extremely wide viewing angle.发光角度大

Suitable for all SMT assembly and solder process.适用于所有的SMT组装和焊接工艺

Available on tape and reel.适用于载带及卷轴

Moisture sensitivity level: Level 2.防潮等级 Level2

Compliance with RoHS and REACH. 符合RoHS和REACH要求

Qualifications: The product qualification test plan is based on the guidelines of AEC-Q102 Stress Test Qualification for Automotive Grade Discrete Semiconductors  
AEC-Q102

### 1.3 Application

Automotive Lighting Interior and Exterior.汽车内饰和外饰照明



## 1.4 Package Dimension

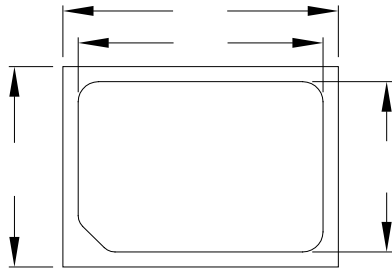

正面视图

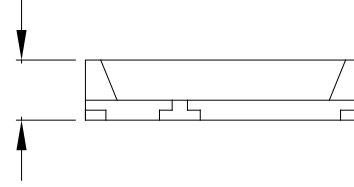

侧面视图

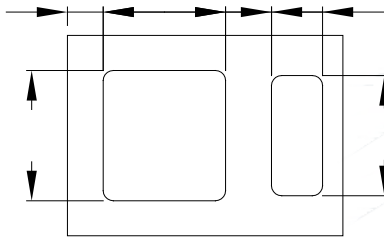

背面视图

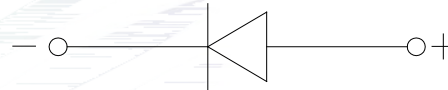

极性

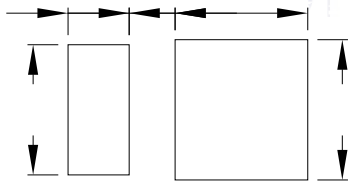

推荐焊盘

### Notes

1. All dimensions units are millimeters.
2. All dimensions tolerances are  $\pm 0.05\text{mm}$  unless otherwise noted.



$\pm 0.05$

## 1.5 Product Parameters

Table 1-1 Electrical / Optical Characteristics at Ts=25°C

| Item                | Symbol      | Test Condition     | Value |      |      | Unit          |
|---------------------|-------------|--------------------|-------|------|------|---------------|
|                     |             |                    | Min.  | Typ. | Max. |               |
| Forward Voltage     | $V_F$       | $I_F=700\text{mA}$ | 2.0   | ---  | 2.6  | V             |
| Reverse Current     | $I_R$       | $V_R=5\text{V}$    | ---   | ---  | 10   | $\mu\text{A}$ |
| Luminous Flux       |             | $I_F=700\text{mA}$ | 105   | ---  | 140  | lm            |
| Dominant wavelength | $\lambda_d$ | $I_F=700\text{mA}$ | 612.5 | 617  | 620  | nm            |
| Viewing Angle       |             | $I_F=700\text{mA}$ | ---   | 120  | ---  | deg           |
| Thermal Resistance. | $R_{THJ-S}$ | $I_F=700\text{mA}$ | ---   | ---  | 15   | /W            |

Table 1-2 Absolute Maximum Ratings at Ts=25°C

| Parameter                     | Symbol    | Rating     | Units |
|-------------------------------|-----------|------------|-------|
| Power Dissipation             | $P_D$     | 2184       | mW    |
| Forward Current               | $I_F$     | 840        | mA    |
| Peak Forward Current          | $I_{FP}$  | 1000       | mA    |
| Reverse Voltage               | $V_R$     | 5          | V     |
| Electrostatic Discharge (HBM) | $E_{SD}$  | 2000       | V     |
| Operating Temperature         | $T_{OPR}$ | -40 ~ +125 |       |
| Storage Temperature           | $T_{STG}$ | -40 ~ +125 |       |
| Junction Temperature          | $T_J$     | 150        |       |

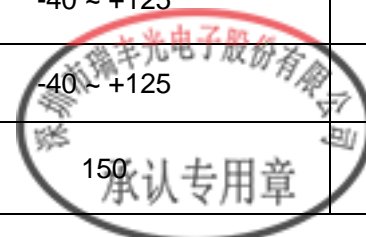

Tel:+86-755-29675000

E-mail:sales@refond.com



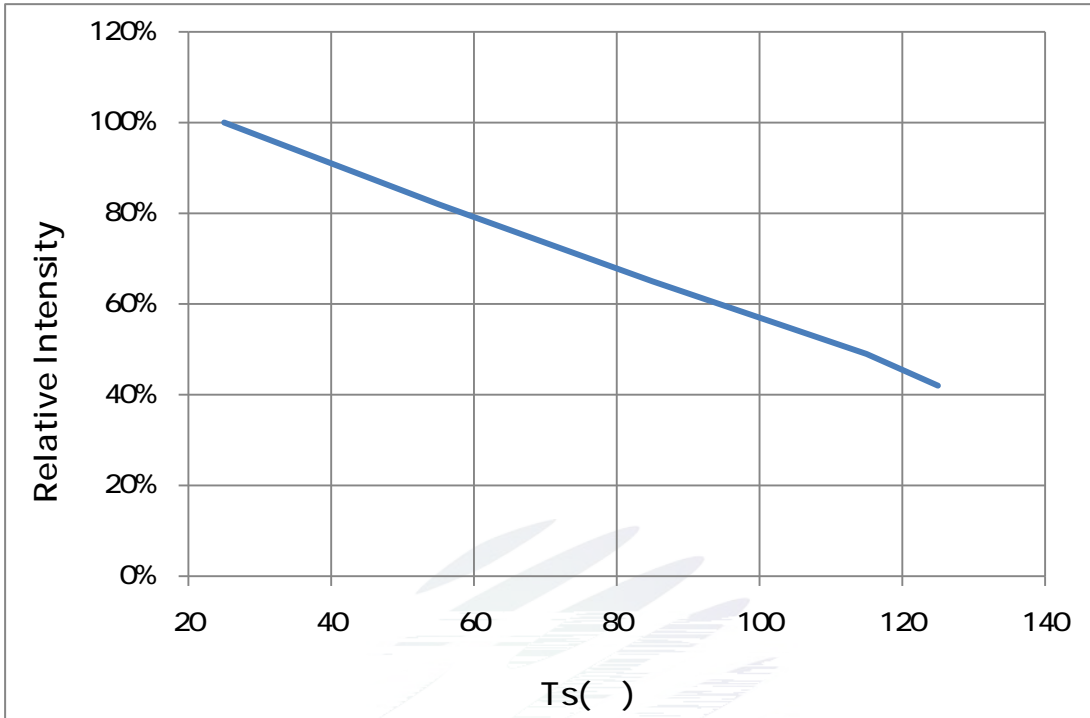

Fig. 1-9 Solder Temperature Vs Relative Intensity

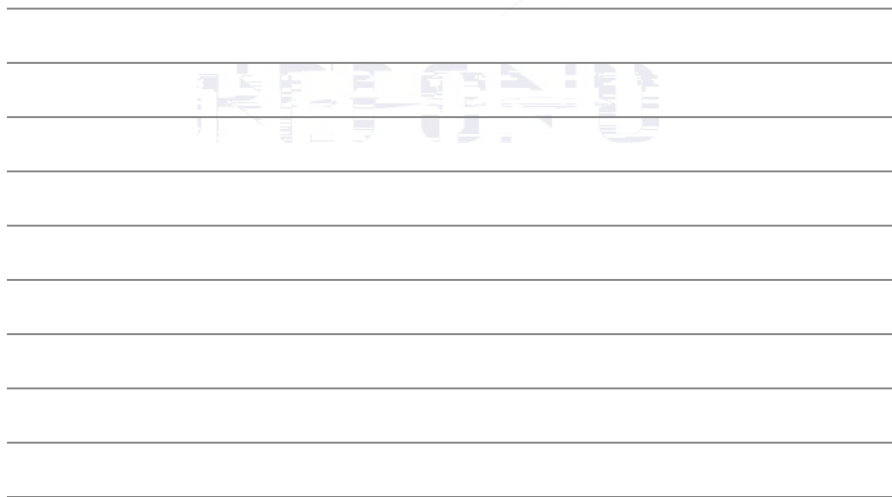

Fig. 1-10 Solder Temperature Vs Forward Current





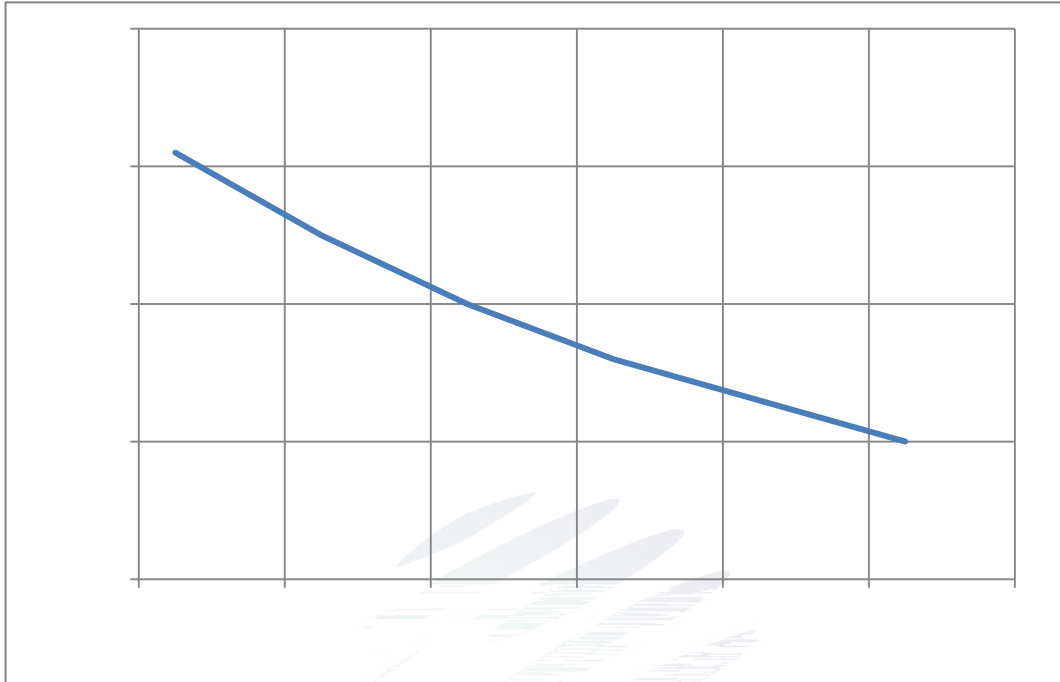

Fig. 1-11 Forward Voltage Vs Solder Temperature

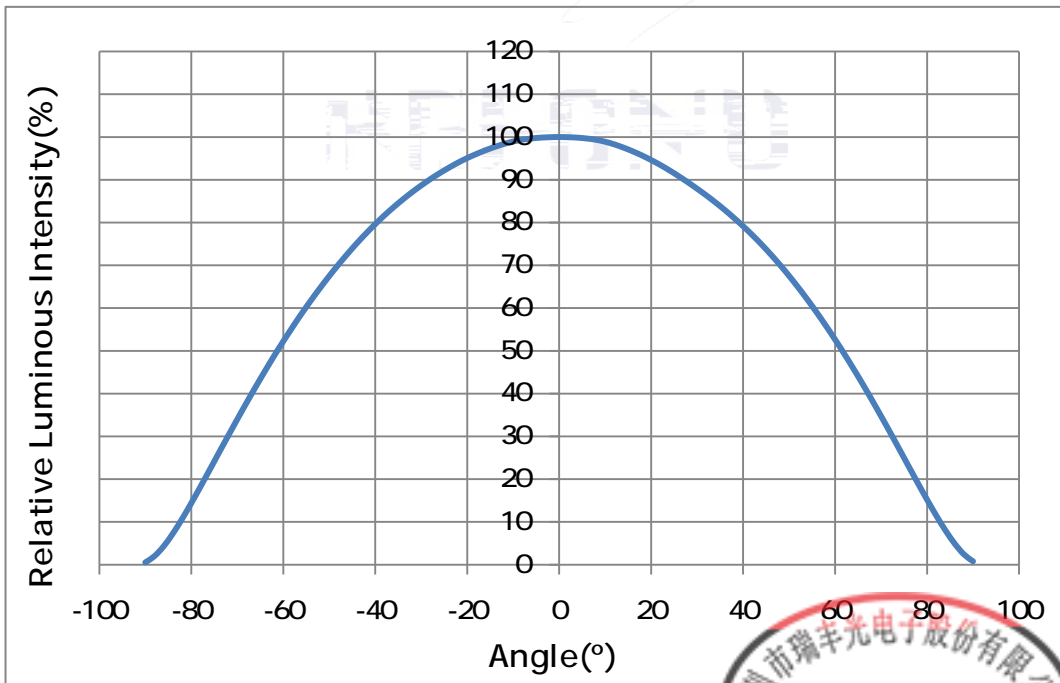
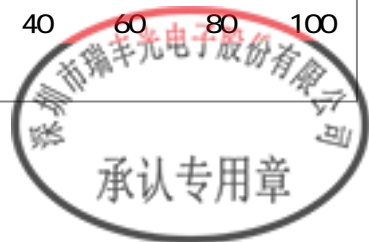

Fig. 1-12 Radiation diagram



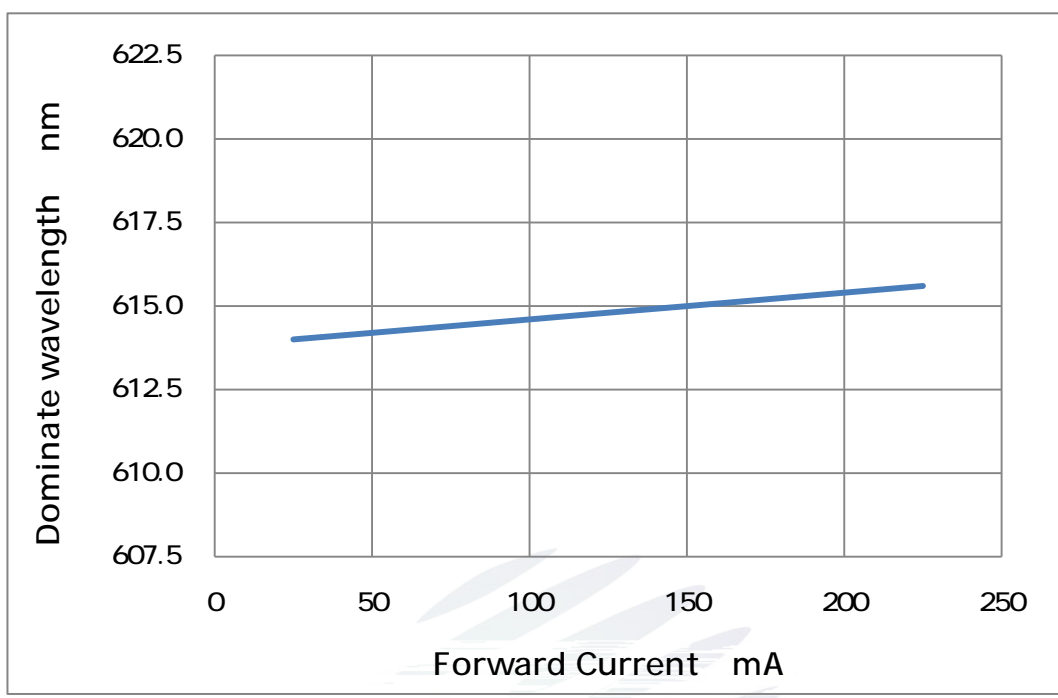

Fig. 1-13 Forward current vs. Dominate wavelength (Ts=25°C)

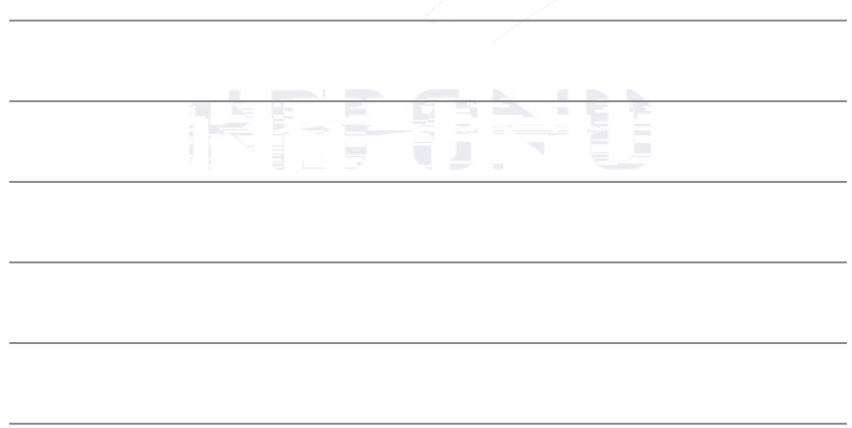

Fig. 1-14 Spectrum Distribution



## 2. Packaging

### 2.1 Packaging Specification

Package:4000pcs/reel.

#### 2.1.1 Carrier Tape Dimension

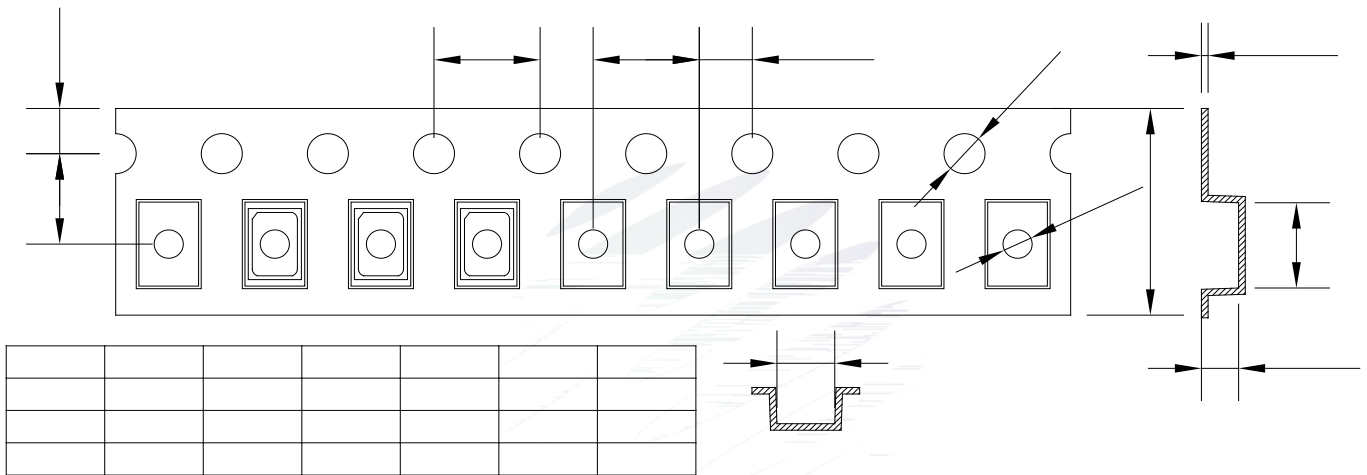

Fig.2-1 Carrier Tape Dimension

#### 2.1.2 Reel Dimension

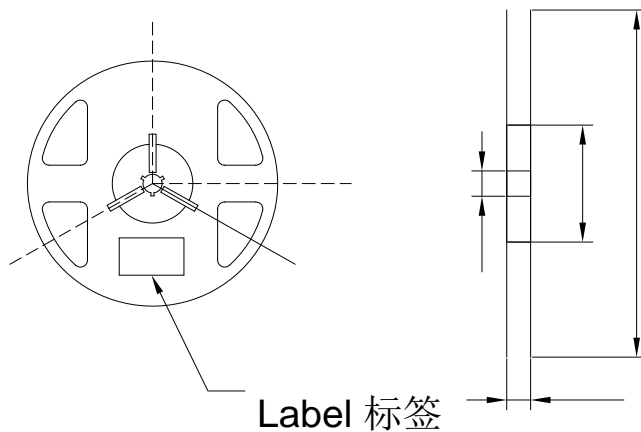

Fig.2-2 Reel Dimension

Table 2-1 Reel Dimension

|   |             |
|---|-------------|
| A | 12± 0.1mm   |
| B | 180± 1mm    |
| C | 60± 1mm     |
| D | 13.0± 0.5mm |

#### Notes

The tolerances unless mentioned  $\pm 0.1$ mm. Unit : mm

$\pm 0.1$



### 2.1.3 Label Form Specification

Table 2-2 Specification

|                |                  |
|----------------|------------------|
| PART NO.       | Part Number      |
| SPEC NO.       | Spec Number      |
| LOT NO.        | Lot Number       |
| BIN CODE       | Bin Code         |
|                | Luminous flux    |
| XY             | Chromaticity Bin |
| V <sub>F</sub> | Forward Voltage  |
| WLD            | Wavelength       |
| QTY            | Packing Quantity |
| DATE           | Made Date        |

Fig. 2-3 Label Form Specification

## 2.2 Moisture Resistant Packing

Fig.2-4 Moisture Resistant Packing

## 2.3 Cardboard Box

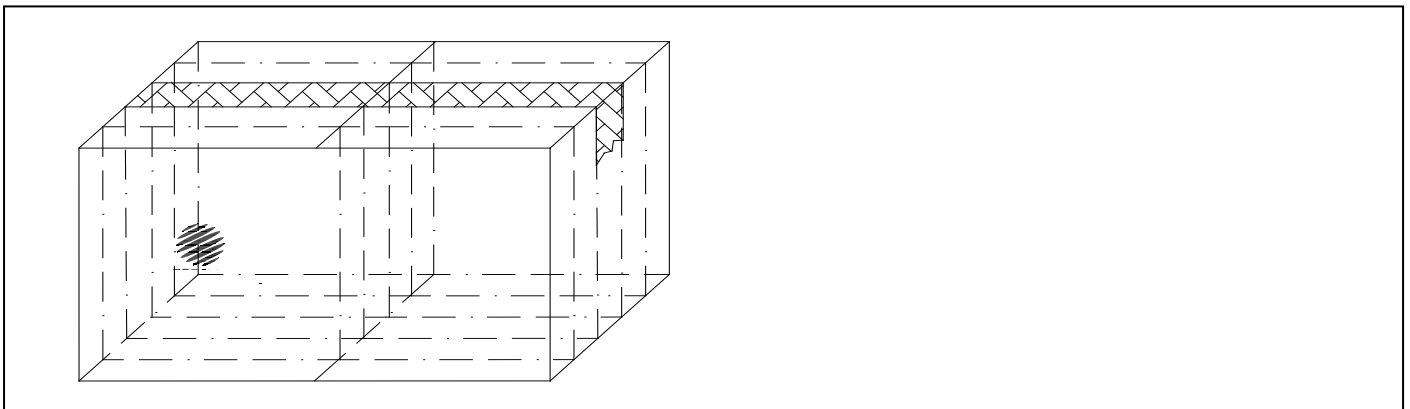

Fig.2-5 Cardboard Box

## 2.4 Reliability Test Items And Conditions



## 2.5 Criteria For Judging Damage

Table 2-4 Criteria For Judging Damage

| Test Items      | Symbol | Test Condition     | Criteria For Judgement |             |
|-----------------|--------|--------------------|------------------------|-------------|
|                 |        |                    | Min.                   | Max.        |
| Forward Voltage | $V_F$  | $I_F=700\text{mA}$ | -                      | U.S.L*)x1.1 |
| Reverse Current | $I_R$  | $V_R = 5\text{V}$  | -                      | U.S.L*)x2.0 |
| Luminous Flux   |        | $I_F=700\text{mA}$ | L.S.L*)x0.7            | -           |

### Notes

- 1.U.S.L: Upper standard level                      L.S.L: Lower standard level
- 2.The above reliability tests is based on the verification of a single/strip LED of Refond's existing experimental platform,the reliability experiment was taken under good heat dissipation conditions. when customers applies the LED to the series and parallel circuit, should take consideration of all the factors such as the current, voltage distribution, heat dissipation and others. / LED  
LED
- 3.The technical information shown in the data sheets is limited to the typical characteristics and circuit examples of the referenced products. It does not constitute the warranting of industrial property nor the granting of any license.



### 3. SMT Reflow Soldering Instructions SMT

#### 3.1 SMT Reflow Soldering Instructions SMT

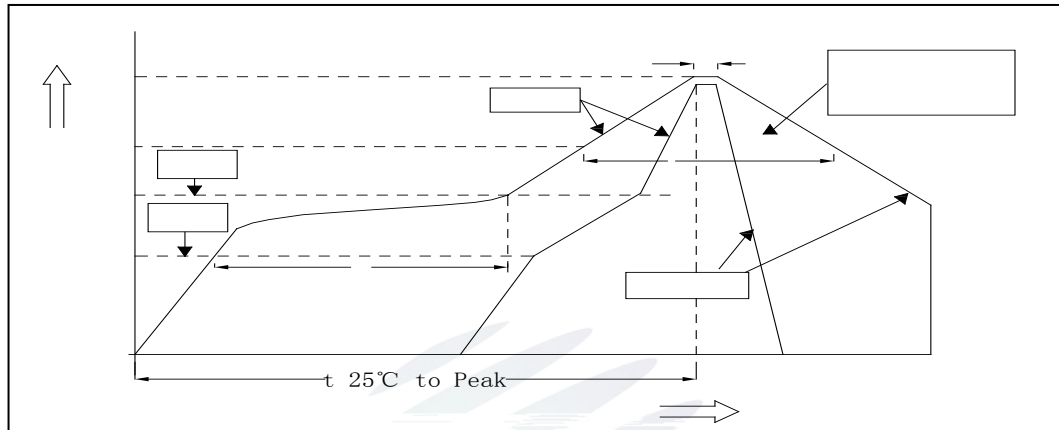
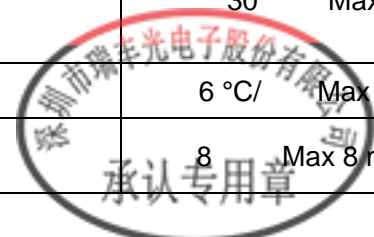

Fig.3-1 SMT Reflow Soldering Instructions SMT

Table 3-1 Reflow parameters 回流焊参数

|  |                                 |          |               |
|--|---------------------------------|----------|---------------|
| Average temperature rise speed                                       | $T_{smax}$ $T_P$                | 3 °C/    | Max 3 °C/ s   |
| Preheating: minimum temperature                                      | ( $T_{smin}$ )                  | 150 °C   |               |
| Preheating: Max temperature  | ( $T_{smax}$ )                  | 200 °C   |               |
| Preheating: Time   | $T_{smin}$ $T_{smax}$           | 60 - 120 | 60s-120s      |
| Time limited to maintain high temperature: the temperature ( $T_L$ ) |                                 | 217 °C   |               |
| Time limited to maintain high temperature: The Time ( $t_L$ )        |                                 | 60       | Max 60s       |
| Peak /Classification of temperature:                                 | / ( $T_P$ )                     | 260 °C   |               |
| Time limit classification of peak temperature time $t_p$             |                                 | 10       | Max 10s       |
| ( $T_P$ ) 5 °C<br>the actual peak temperature ( $T_P$ )              | Hold time within 5 °C with      | 30       | Max 30s       |
| Cooling speed  |                                 | 6 °C/    | Max 6 °C/ s   |
| 25 °C  | Needed time from 25 °C to $T_p$ | 8        | Max 8 minutes |



## Notes

(1)Reflow soldering should not be done more than twice. If more than 24 hours between the two solderings ,LED will be damaged.

24 LED

(2)When soldering , do not put stress on the LEDs during heating.

### 3.1.1 Repairing

Repairing should not be done after the LEDs have been soldered. When repairing is unavoidable,a double-head soldering iron should be used (as below figure). It should be confirmed in advance whether the characteristics of LEDs will or not be damaged by repairing.

LED

LED

### 3.1.2 Cautions

The encapsulated material of the LEDs is silicone. Therefore the LEDs have a soft surface on the top of package. The pressure to the top surface will be impacted on the reliability of the LEDs. Precautions should be taken to avoid the strong pressure on the encapsulated part. So when use the picking up nozzle, the pressure on the silicone resin should be proper. LED

LED

(2)



## 4. Handling Precautions

### 4.1 Handling Precautions

(1) LED operating environment and sulfur element composition cannot be over 100PPM in the LED mating usage material. This is provided for informational purposes only and is not a warranty or endorsement.

LED

100PPM

(2) In order to prevent external material from getting into the inside of LED, which may cause the malfunction of LED, the single content of Bromine element is required to be less than 900PPM, the single content of Chlorine element is required to be less than 900PPM, the total content of Bromine element and Chlorine element in the external materials of the application products is required to be less than 1500PPM. This is provided for informational purposes only and is not a warranty or endorsement.

LED

LED

900PPM

900PPM

1500PPM

(3) VOCs (Volatile organic compounds) emitted from materials used in the construction of fixtures can penetrate silicone encapsulants of LEDs and discolor when exposed to heat and photonic energy. The result can be a significant loss of light output from the fixture. Knowledge of the properties of the materials selected to be used in the construction of fixtures can help prevent these issues. Refond advises against the use of any chemicals or materials that have been found or are suspected to have an adverse effect on device performance or reliability. To verify compatibility, Refond recommends that all chemicals and materials be tested in the specific application and environment for which they are intended to be used. Attaching LEDs, do not use adhesives that outgas organic vapor.

LED

LED

LED

LED

(4) Handle the component along the side surface by using forceps or appropriate tools, Do not directly touch or Handle the silicone lens surface, it may damage the internal circuitry.



Fig 4-1Cautions

(5) In designing a circuit, the current through each LED can not exceed the absolute maximum rating specified for each LED. In the mean while, resistors for protection should be applied, other wise slight voltage shift will cause big current change, burn out may happen. The driving circuit must be designed to allow forward voltage only when it is ON or OFF. If the reverse voltage is applied to LED, migration can be generated resulting in LED damage.

LED

LED

(6) Thermal Design is paramount importance because heat generation may result in the Characteristics decline, such as brightness decreased, Color change and so on. Please consider the heat generation of the LEDs when making the system design.

LED

Table 4-1 Storage

|               | Conditions                  | Temperature | Humidity | Time   |
|---------------|-----------------------------|-------------|----------|--|
|               | Before Opening Aluminum Bag | 30          | 75%      | Within 1 Year From Date                          |
| Storage<br>儲存 | After Opening Aluminum Bag  | 30          | 60%      | Recommended for use<br>within 24 hours<br><br>24 |



**Version History/**

| Date       | Revisor   | Version | Verifier   | Remarks   |
|------------|-----------|---------|--|-----------|
| 2022/08/25 | Xian Zhou | E0      | Zhu Yiming   | New issue |
|            |           |         |  |           |
|            |           |         |  |           |
|            |           |         |  |           |
|            |           |         |  |           |
|            |           |         |  |           |
|            |           |         |  |           |
|            |           |         |  |           |
|            |           |         |  |           |
|            |           |         |  |           |
|            |           |         |  |           |
|            |           |         |  |           |
|            |           |         |  |           |
|            |           |         |  |           |
|            |           |         |  |           |
|            |           |         |  |           |
|            |           |         |  |           |
|            |           |         |  |           |
|            |           |         |  |           |
|            |           |         |  |           |
|            |           |         |  |           |
|            |           |         |  |           |
|            |           |         |  |           |
|            |           |         |  |           |
|            |           |         |  |           |
|            |           |         |  |           |



REFOND

Declare

This specification is written both in English and in Chinese and the latter is formal.

