

SPECIFICATION

LT P/N

LT2604WH-A-Q

R&D

Mass Product



Contents

1. Description	3
1.1 General Description	3
1.2 Features	3
1.3 Application	3
1.4 Package Dimension	4
1.5 Product Parameters	4
1.6 Bin Range Of Forward Voltage and Luminous Intensity (IF=20mA)	BIN
(IF=20mA)	6
1.7 Typical Optical Characteristics Curves	6
2. Packaging	13
2.1 Packaging Specification	13
2.1.1 Carrier Tape Dimension	13
2.1.2 Reel Dimension	12
2.1.3 Label Form Specification	14
2.2 Moisture Resistant Packing	14
2.3 Cardboard Box	14
2.4 Reliability Test Items And Conditions	14
2.5 Criteria For Judging Damage	15
3. SMT Reflow Soldering Instructions SMT	16
3.1 SMT Reflow Soldering Instructions SMT	16
4. Handling Precautions	18
4.1 Handling Precautions	18

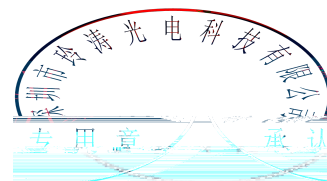

1. Description

1.1



The White LED, which was fabricated by using a blue chip and the phosphor.

Product Package: 2.6mmX0.7mmX0.4mm.

LED,

: 2.6mmX0.7mmX0.4mm

1.2 Features

PLCC Package. PLCC

Wide viewing angle.

Suitable for all SMT assembly and solder process.

SMT

Available on tape and reel.

Moisture sensitivity level: Level 3.

Level 3

RoHS compliant. RoHS

1.3 Application

LCD Back Light. LCD

Mobile Phones.

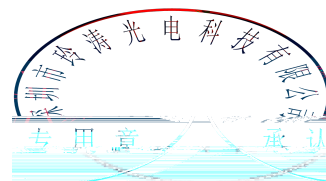

Table 1-2 Absolute Maximum Ratings at Ts=25°C

Parameter	Symbol	Rating	Units
Forward Current	I_F	30	mA
Peak Forward Current	I		

Notes

- 1/10 Duty cycle, 0.1ms pulse width. 0.1ms, 1/10.
- The above forward voltage measurement allowance tolerance is $\pm 0.03V$. $\pm 0.03V$.
- The above color coordinates measurement allowance tolerance is ± 0.003 . ± 0.003 .
- The above luminous intensity measurement allowance tolerance $\pm 3\%$. $\pm 3\%$.
- Care is to be taken that power dissipation does not exceed the absolute maximum rating of the product.
- All measurements were made under the standardized environment of LT.
- When the LEDs are in operation the maximum current should be decided after measuring the package temperature, junction temperature should not exceed the maximum rate. LED

1.6 Bin Range Of Forward Voltage and Luminous Intensity (IF=20mA)

BIN (IF=20mA)

Table 1-3 Bin Range Of Luminous Intensity Bin (IF=20mA)

BIN CODE	IF=20mA Test			
		Max (mcd)	Min (lm)	Max (lm)
30	2150	2250	6.00	6.25
31	2250	2350	6.25	6.50
32	2350	2450	6.50	6.75
33	2450	2550	6.75	7.00
34	2550	2650	7.00	7.25
35	2650	2750	7.25	7.50
36	2750	2850	7.50	7.75
37	2850	2950	7.75	8.00
38	2950	3050	8.00	8.25
39	3050	3150	8.25	8.50
40	3150	3250	8.50	8.75
41	3250	3350	8.75	9.00
42	3350	3450	9.00	9.25
43	3450	3550	9.25	9.5
44	3550	3650	9.5	9.75
45	3650	3750	9.75	10.0

Table 1-4 Bin Range Of Forward Voltage Bin

BIN CODE	Min.	Max.	Unit	Condition
V0	2.7	2.8	V	IF=20mA
V1	2.8	2.9		
V2	2.9	3.0		
V3	3.0	3.1		
V4	3.1	3.2		
V5	3.2	3.3		

Notes

VF Tolerance: $\pm 0.03V$ @ IF= 20mA @ Ta=25

IV Tolerance: $\pm 3\%$ @ IF= 20mA @ Ta=25

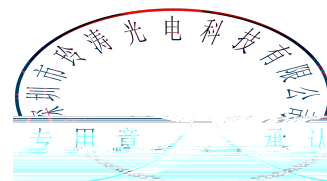
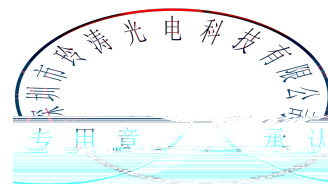

Fig. 1-5 The C.I.E. 1931 Chromaticity Diagram: (L&T&H)

Table 1-6 Bin Range of Chromaticity Coordinates Block (IF=20mA ; Ta=25)

L0	0.2341	0.2016	T0	0.2489	0.2072	H1	0.2638	0.2192
	0.2388	0.2113		0.2532	0.2151		0.2681	0.2272
	0.2443	0.2083						



L5	0.2576	0.2501	T5	0.2704	0.2471	H6	0.2853	0.2591
	0.2623	0.2598		0.2747	0.2551		0.2896	0.2670
	0.2678	0.2568		0.2798	0.2521		0.2947	0.2640
	0.2631	0.2471		0.2755	0.2441		0.2904	0.2561
L6	0.2623	0.2598	T6	0.2747	0.2551	H7	0.2896	0.2670
	0.2670	0.2695		0.2790	0.2630		0.2939	0.2750
	0.2725	0.2665		0.2841	0.2600		0.2990	0.2720
	0.2678	0.2568		0.2798	0.2521		0.2947	0.2640
L7	0.2670	0.2695	T7	0.2790	0.2630	H8	0.2939	0.2750
	0.2717	0.2792		0.2833	0.2710		0.2982	0.2829
	0.2772	0.2762		0.2884	0.2680		0.3033	0.2799
	0.2725	0.2665		0.2841	0.2600		0.2990	0.2720
L8	0.2717	0.2792	T8	0.2833	0.2710	H9	0.2982	0.2829
	0.2764	0.2889		0.2876	0.2789		0.3025	0.2908
	0.2819	0.2859		0.2927	0.2759		0.3076	0.2878
	0.2772	0.2762		0.2884	0.2680		0.3033	0.2799
L9	0.2764	0.2889	T9	0.2876	0.2789	H10	0.3025	0.2908
	0.2811	0.2986		0.2919	0.2868		0.3068	0.2987
	0.2866	0.2956		0.2970	0.2838		0.3119	0.2957
	0.2819	0.2859		0.2927	0.2759		0.3076	0.2878
L10	0.2811	0.2986	T10	0.2919	0.2868			
	0.2858	0.3083		0.2962	0.2947			
	0.2913	0.3053		0.3013	0.2917			
	0.2866	0.2956		0.2970	0.2838			

Fig. 1-7 The C.I.E. 1931 Chromaticity Diagram: (LA&LB)

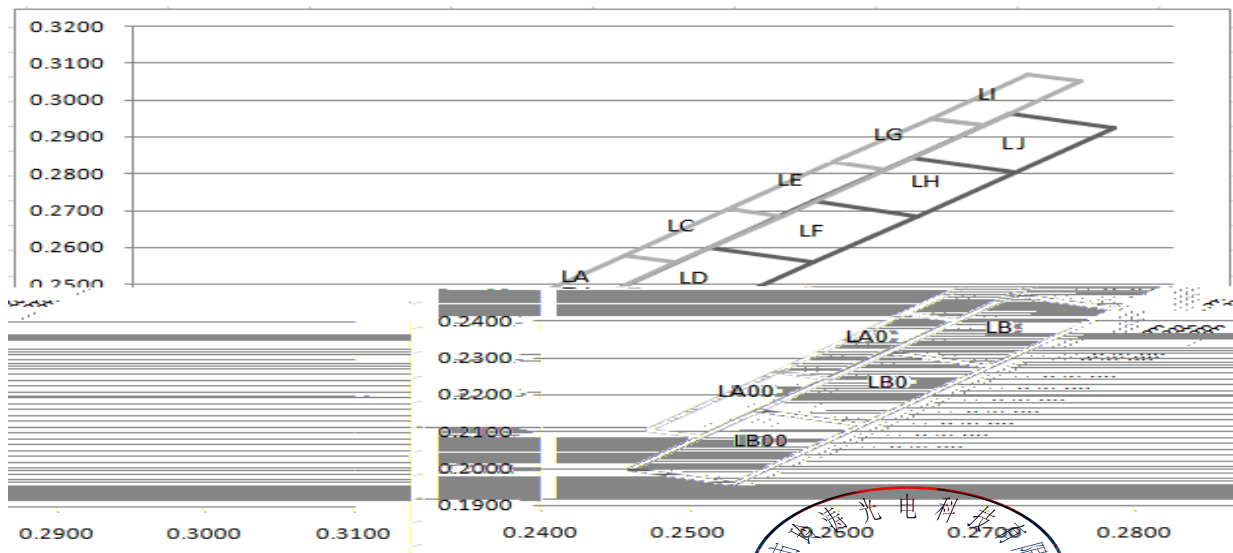

Table 1-8 Bin Range of Chromaticity Coordinates Block (IF=20mA ; Ta=25℃)



LA00	0.2472	0.2105	LA0	0.2558	0.2263	LA	0.2644	0.2421
	0.2558	0.2263		0.2644	0.2421		0.2730	0.2579
	0.2593	0.2243		0.2679	0.2401		0.2765	0.2559
	0.2507	0.2085		0.2593	0.2243		0.2679	0.2401
LC	0.2730	0.2579	LE	0.2801	0.2705	LG	0.2871	0.2831
	0.2801	0.2705		0.2871	0.2831		0.2937	0.2950
	0.2836	0.2685		0.2906	0.2811		0.2972	0.2930
	0.2765	0.2559		0.2836	0.2685		0.2906	0.2811
LI	0.2937	0.2950						
	0.3002	0.3070						

Table 1-10 Bin Range of Chromaticity Coordinates Block (IF=20mA ;Ta=25)

LR1	0.2386	0.2021	LR2	0.2446	0.2144	LR3	0.2506	0.2268
	0.2446	0.2144		0.2506	0.2268		0.2565	0.2391
	0.2501	0.2114		0.2561	0.2238		0.2620	0.2361
	0.2441	0.1991		0.2501	0.2114		0.2561	0.2238
LR4	0.2565	0.2391	LR5	0.2625	0.2515	LR6	0.2685	0.2638
	0.2625	0.2515		0.2685	0.2638		0.2745	0.2762
	0.2680	0.2485		0.2740	0.2608		0.2800	0.2732
	0.2620	0.2361		0.2680	0.2485		0.2740	0.2608
LR7	0.2745	0.2762	LR8	0.2805	0.2885	LR9	0.2865	0.3009
	0.2805	0.2885		0.2865	0.3009		0.2924	0.3132
	0.2860	0.2855		0.2920	0.2979		0.2979	0.3102
	0.2800	0.2732		0.2860	0.2855		0.2920	0.2979
LR10	0.2924	0.3132	TB0	0.2510	0.2113	TB1	0.2575	0.2232
	0.2984	0.3256		0.2575	0.2232		0.2639	0.2352
	0.3039	0.3226		0.2626	0.2202		0.2690	0.2322
	0.2979	0.3102		0.2562	0.2082		0.2626	0.2202
TB2	0.2639	0.2352	TB3	0.2704	0.2471	TB4	0.2768	0.2591
	0.2704	0.2471		0.2768	0.2591		0.2833	0.2710
	0.2755	0.2441		0.2819	0.2561		0.2884	0.2680
	0.2690	0.2322		0.2755	0.2441		0.2819	0.2561
TB5	0.2833	0.2710	LH1	0.2573	0.2073	LH2	0.2638	0.2192
	0.2897	0.2829		0.2638	0.2192		0.2702	0.2311
	0.2948	0.2799		0.2689	0.2162		0.2754	0.2281
	0.2884	0.2680		0.2624	0.2043		0.2689	0.2162
LH3	0.2702	0.2311	LH4	0.2767	0.2431	LH5	0.2832	0.2550
	0.2767	0.2431		0.2832	0.2550		0.2896	0.2669
	0.2818	0.2401		0.2882	0.2520		0.2947	0.2639
	0.2754	0.2281		0.2818	0.2401		0.2882	0.2520
LH6	0.2896	0.2669	LH7	0.2960	0.2789	LH8	0.3025	0.2908
	0.2960	0.2789		0.3025	0.2908		0.3090	0.3027
	0.3011	0.2759		0.3076	0.2878		0.3141	0.2997
	0.2947	0.2639		0.3011	0.2759		0.3076	0.2878
O1	0.2688	0.2163	O2	0.2753	0.2282	O3	0.2817	0.2401
	0.2753	0.2282		0.2817	0.2401		0.2882	0.2521
	0.2804	0.2252		0.2869	0.2371		0.2933	0.2491
	0.2739	0.2133		0.2804	0.2252		0.2869	0.2371
O4	0.2882	0.2521	O5	0.2947	0.2640	O6	0.3011	0.2759
	0.2947	0.2640		0.3011	0.2759		0.3075	0.2879
	0.2997	0.2610		0.3062	0.2729		0.3126	0.2849
	0.2933	0.2491		0.2997	0.2610		0.3062	0.2729
O7	0.3075	0.2879						
	0.3140	0.2998						
	0.3191	0.2968						
	0.3126	0.2849						

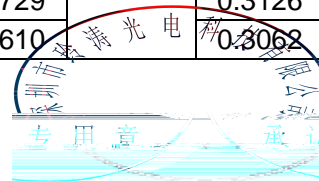

Fig. 1-11 The C.I.E. 1931 Chromaticity Diagram: (LB2&K)

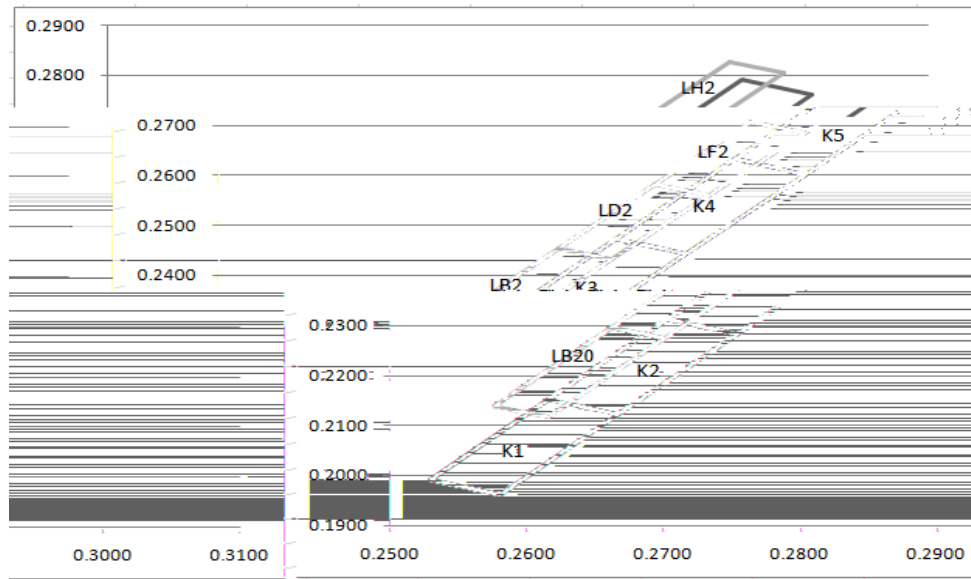
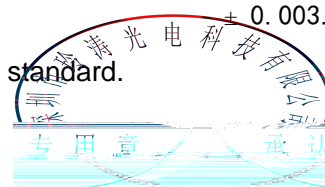

Table 1-12 Bin Range of Chromaticity Coordinates Block (IF=20mA ; Ta=25)

LB20	0.2576	0.2139	LB2	0.2662	0.2297	LD2	0.2748	0.2455
	0.2662	0.2297		0.2748	0.2455		0.2819	0.2581
	0.2701	0.2275		0.2787	0.2433		0.2858	0.2559
	0.2615	0.2117		0.2701	0.2275		0.2787	0.2433
LF2	0.2819	0.2581	LH2	0.2889	0.2707	K1	0.2529	0.1992
	0.2889	0.2707		0.2955	0.2826		0.2616	0.2152
	0.2928	0.2685		0.2994	0.2804		0.2667	0.2122
	0.2858	0.2559		0.2928	0.2685		0.2580	0.1962
K2	0.2616	0.2152	K3	0.2703	0.2312	K4	0.2790	0.2472
	0.2703	0.2312		0.2790	0.2472		0.2877	0.2632
	0.2754	0.2282		0.2841	0.2442		0.2928	0.2602
	0.2667	0.2122		0.2754	0.2282		0.2841	0.2442
K5	0.2877	0.2632						
	0.2964	0.2792						
	0.3015	0.2762						
	0.2928	0.2602						

Notes

- 1 Measurement uncertainty of the color coordinates: ± 0.003 .
- 2 The new white dustbin refers to the application of small backlight standard.



1.7 Typical Optical Characteristics Curves

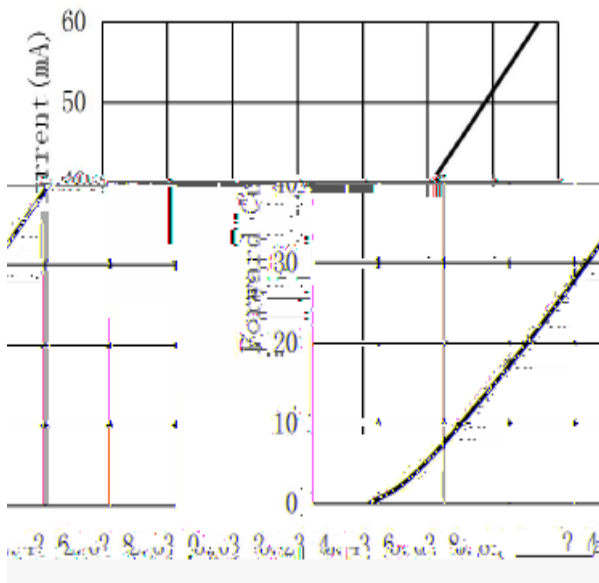

Fig. 1-13 Forward Voltage Vs Forward Current

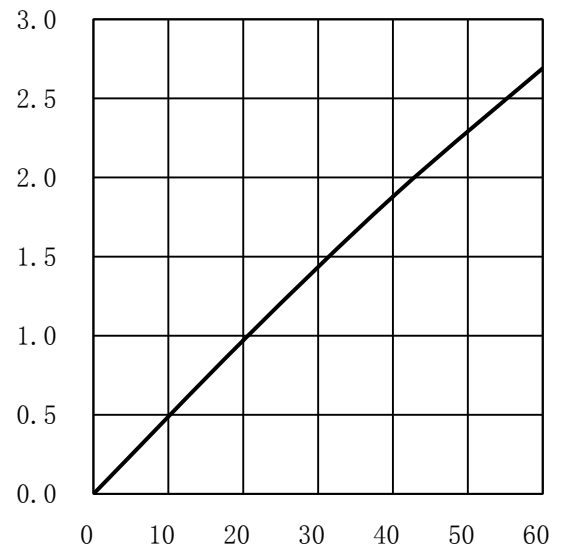

Fig. 1-14 Forward Current Vs Relative Intensity

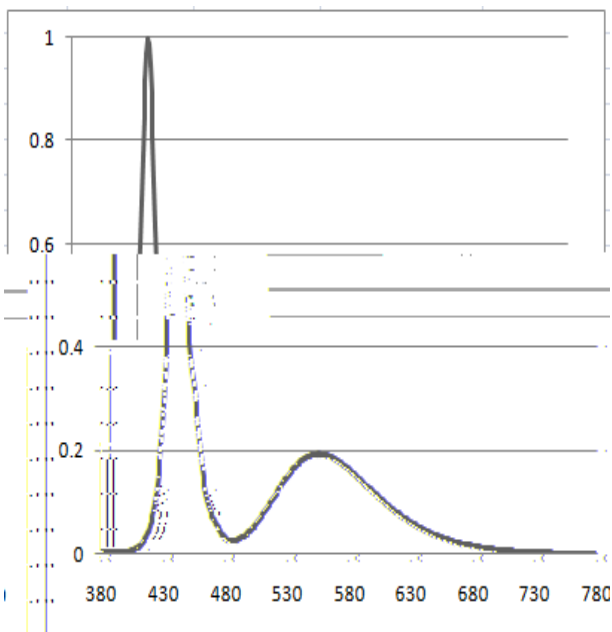

Fig. 1-16 Spectrum Distribution

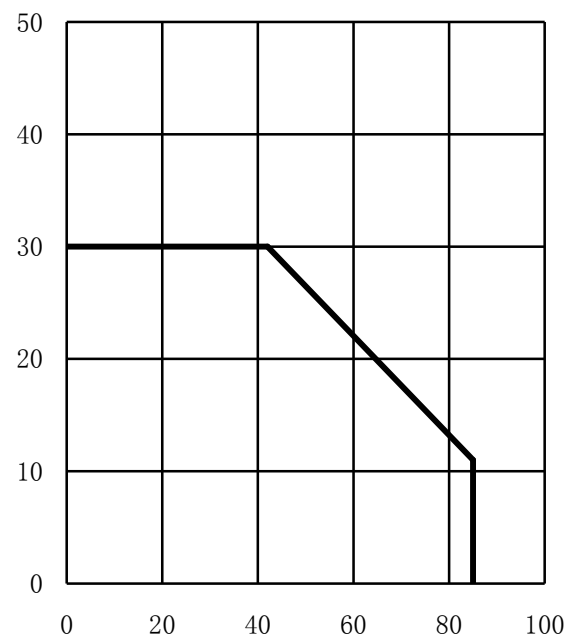
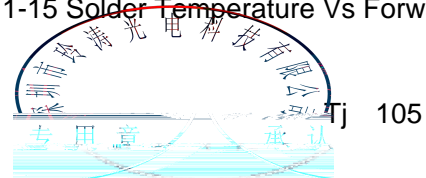

Fig. 1-15 Solder Temperature Vs Forward Current



2. Packaging

2.1 Packaging Specification

Package:5000pcs/reel. 5000pcs

2.1.1 Carrier Tape Dimension

P0	4.00±0.10	P2	2±0.05	P1	4.00±0.10	D0	1.50±0.10	D1	0.65±0.10
E	1.75±0.10	F	3.50±0.10	W	8.00±0.20	A0	0.95±0.10	T	0.20±0.10

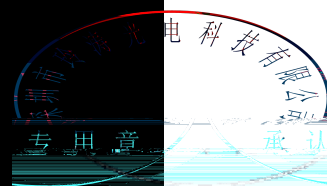

2.1.2 Label Form Specification

Table 2-2 Label Map



Table 2-3 Label Form Specification

PART NO.	Part Number
BIN CODE	Bin Code
IV	Luminous intensity
V _F	Forward Voltage
WL	Wavelength
QTY	Packing Quantity
DATE	Made Date
LOT NO	Lot Number

2.2 Moisture Resistant Packing

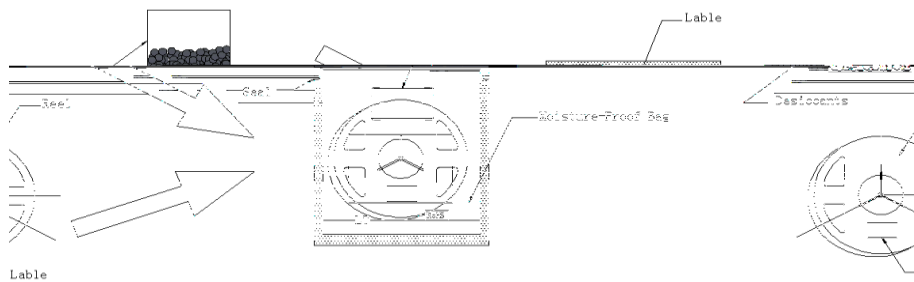

Fig.2-4 Moisture Resistant Packing

2.3 Cardboard Box

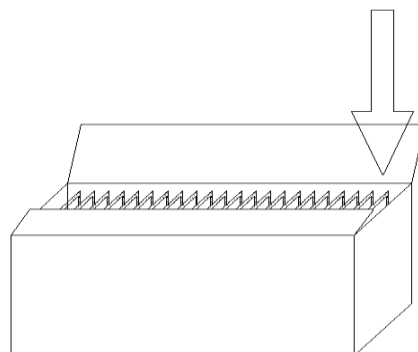
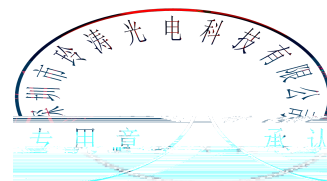

Fig.2-5 Cardboard Box



2.4 Reliability Test Items And Conditions

Table 2-6 Reliability Test Items And Conditions

Test Items	Test Condition	Time	Quantity	Ac/Re /
Reflow	Temp:260 max T=10 sec	---	20pcs.	0/1
Thermal Shock	-40 20min 10s 100 20min	100 cycle	20pcs.	0/1
High Temperature Storage	Temp:100	1000hrs.	20pcs.	0/1
Low Temperature Storage	Temp:-40	1000hrs.	20pcs.	0/1
Life Test	Ta=25 If=20mA	1000hrs.	20pcs.	0/1
High Temperature and Humidity storage	60 / 90%RH	1000hrs.	20pcs.	0/1
Temperature Humidity Operation Life	60 / 90%RH If=15mA	500hrs	20pcs.	0/1

2.5 Criteria For Judging Damage

Table 2-7 Criteria For Judging Damage

Test Items	Symbol	Test Condition	Criteria For Judgement	
			Min.	Max.
Forward Voltage	V _F	I _F =20mA		
Reverse Current	I _R	V _R = 5V		>U.S.L*)x2.0

Luminous Flux		$I_F=20\text{mA}$	$<L.S.L^*)\times 0.7$	-
---------------	--	-------------------	-----------------------	---

Notes

- 1.U.S.L: Upper standard level L.S.L: Lower standard level
- 2.The above reliability tests is based on the verification of a single/strip LED of LT existing experimental platform,the reliability experiment was taken under good heat dissipation conditions. when customer

Preheating: Time	Tsmin	Tsmax	60 - 120	60s-120s
Time limited to maintain high temperature: the temperature		(TL)	217 °C	
Time limited to maintain high temperature: The Time		(tL)	60	Max 60s
Peak /Classification of temperature:	/	(TP)	260 °C	
Time limit classification of peak temperature time		tp	10	Max 10s
(TP) 5 °C		Hold time within 5 ° C with the	30	Max 30s
actual peak temperature (TP)				
Cooling speed			6 °C/	Max 6 °C/ s
25 °C		Needed time from 25 °C to Tp	8	Max 8 minutes

Notes

(1)Reflow soldering should not be done more than twice. If more than 24 hours between the two solderings , LED will be damaged.

24 LED

(2)Whensoldering , do not put stress on the LEDs during heating.

3.1.1 Soldering Iron

(1) When do soldering by hand, keep the temperature of iron below less 300°C less than 3 seconds.

300

3

(2) Soldering by hand should be done only one time.

3.1.2 Repairing

Repairing should not be done after the LEDs have been soldered. When repairing is unavoidable, a double-head soldering iron should be used (as below figure). It should be confirmed in advance whether the characteristics of LEDs will or not be damaged by repairing.

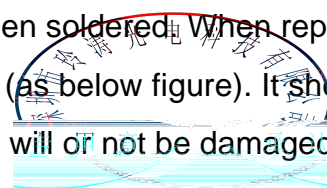

LED

LED

3.1.3 Cautions

(1) The encapsulated material of the LEDs is silicone. Therefore the LEDs have a soft surface on the top of package. The pressure to the top surface will be impacted on the reliability of the LEDs. Precautions should be taken to avoid the strong pressure on the encapsulated part. So when use the picking up nozzle, the pressure on the silicone resin should be proper. LED

LED

(2) 2)

900PPM

900PPM

1500PPM.

(3) VOCs (Volatile organic compounds) emitted from materials used in the construction of fixtures can penetrate silicone encapsulants of LEDs and discolor when exposed to heat and photonic energy. The result can be a significant loss of light output from the fixture. Knowledge of the properties of the materials selected to be used in the construction of fixtures can help prevent these issues. LT advises against the use of any chemicals or materials that have been found or are suspected to have an adverse effect on device performance or reliability. To verify compatibility, LT recommends that all chemicals and materials be tested in the specific application and environment for which th

LED

(7) Compared to standard encapsulants, silicone is generally softer, and the surface is more likely to attract dust, requiring special care during processing. In cases where a minimal level of dirt and dust particles cannot be guaranteed, a suitable cleaning solution must be applied to the surface after the soldering of components. LT suggests using isopropyl alcohol for cleaning. In case other solvents are used, it must be assured that these solvents do not dissolve the package or resin. Ultrasonic cleaning is not recommended. Ultrasonic cleaning may cause damage to the LED.

LED

Table 4-1 Storage

Conditions		Temperature	Humidity	Time
Storage	Before Opening Aluminum Bag	30	75%	Within 1 Year From Date
	After Opening Aluminum Bag	30	60%	24hours 24
Baking		60± 5	-	24hours 24

(8) If the moisture absorbent material (silica gel) has faded away or the LEDs have exceeded the storage time, baking treatment should be performed after unpacking and based on the following condition (65±5) °C for above 24 hours.

60± 5

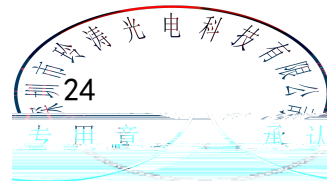

If the package is flatulence or damaged, please notify the sales staff to assist.

(9) Similar to most Solid state devices; LEDs are sensitive to Electro-Static Discharge (ESD) and Electrical Over Stress (EOS).

LED

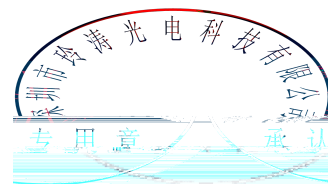

Version History/

Date	Revisor	Version	Verifier	Remarks
2019/8/14		E/0		
2019/9/19		E/1		

