

# SPECIFICATION





optoelectronics  
玲涛光电

---

..

.....

.



## 1.1 Generall

## 1.2 Feature:

y

y

y

y

y

y

## 1.3

y

## 1.4

---

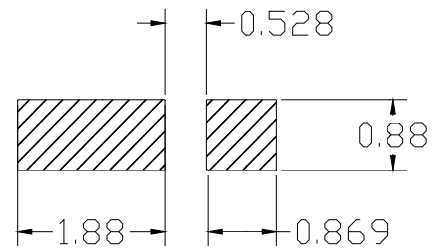
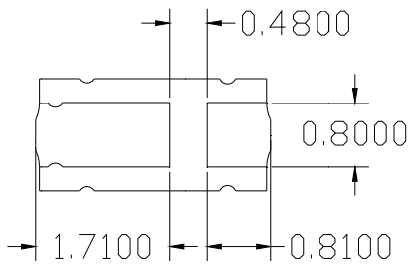
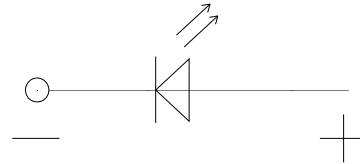
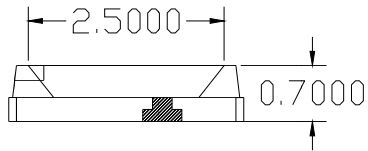
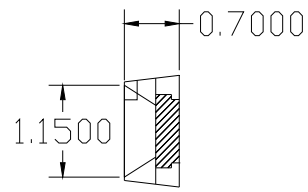
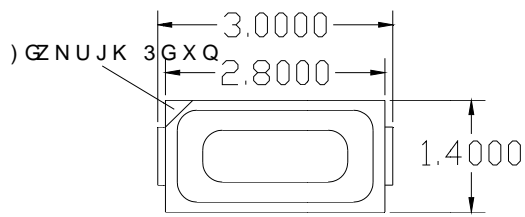

5 H F R H Q G H R G L V L Q G S

r

## 1.5 Product Parameters



## 1.6 Bin Rai BIN

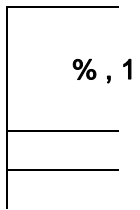

% , 1& 2' (	0 L Q	0 D [	8 Q L W	& R Q L W L R Q

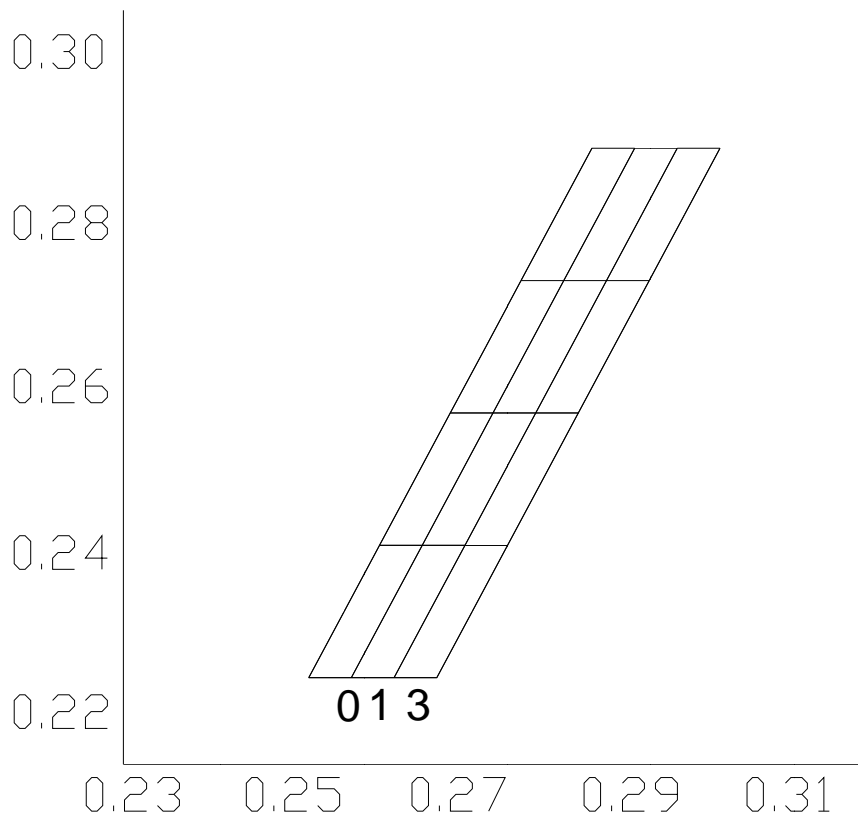





## 1.7 Typical Optical

8 K

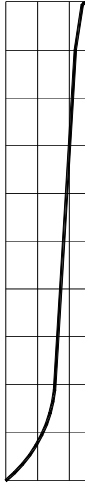

'SHOZTKSVKXGZ[X  
) [XXKTZ

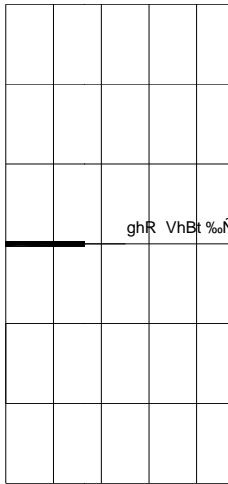

ghR VhBt %Nhff\*6v^1Swd wèR VhBrVhBt %,%l -á v^1 Öf , vCÁKSP%h,V aEa^mV wh9wl € u\$WXSv™™ w^T Á "€0 u\$WXSv™™ w^fi, xE u\$WXSv™™ w^d•L x€ xt

'SHOKTZ ZKS

'SHOKT:KSVKXGZ[XKX]G XJ <MRZG

,UX]GXJ<U <

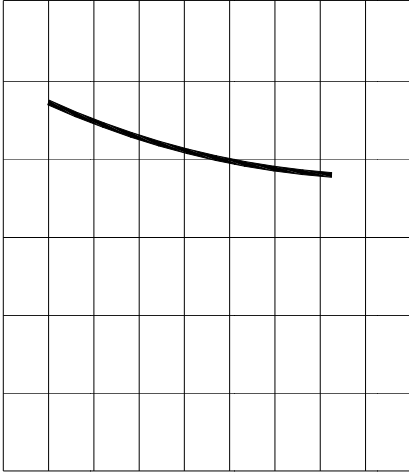

'SHOKTZ ZKXKXGG -

HOKT:KSVKXGZ[XKX]G XJ <MRZG

8KRGZO\K 2[SOTU[Y,R[^

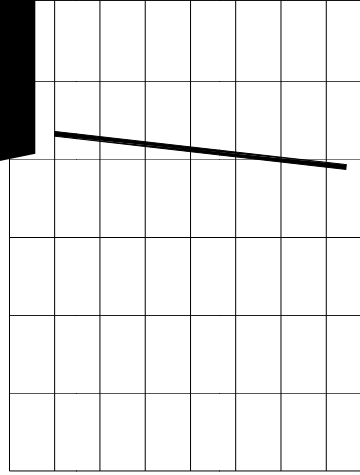

'SHOKTZ ZKXKXGG -

'RRU]GHRK ,UX]GXJ ) [XXKTZ

\*[Z\_ 8GZO\URRU]GHRK,XJ ) [XXKTZ

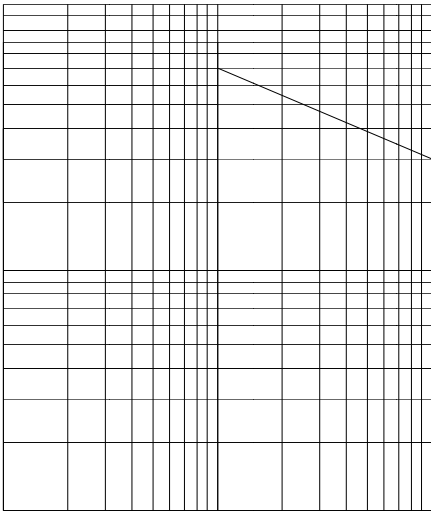

[Z\_ 8GZO\URRU]GHRK,XJ ) [XXKTZ

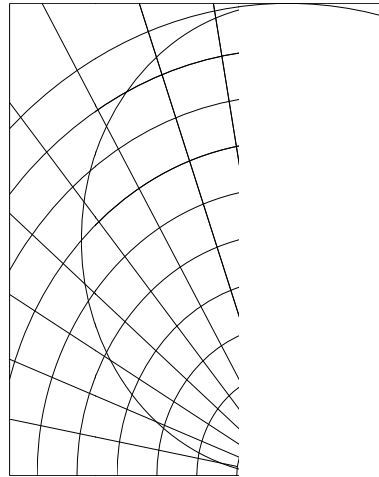

8KRGZO\K 2[SOTU[Y,R[^



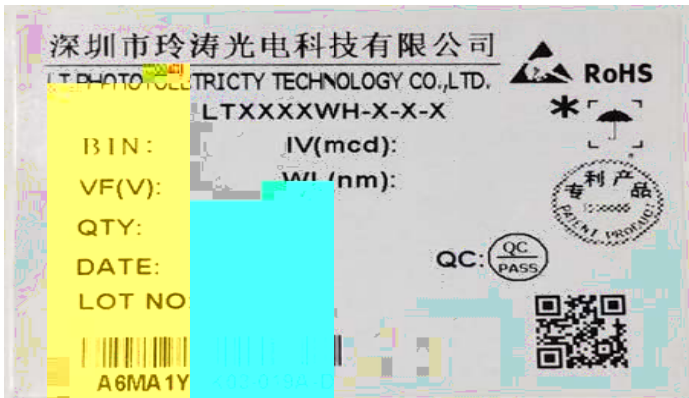

---

---

---

---

---

---

---

---

©!Q'

## 2.2 Moisture Resistant Packing

## 2.3 Cardboard Box

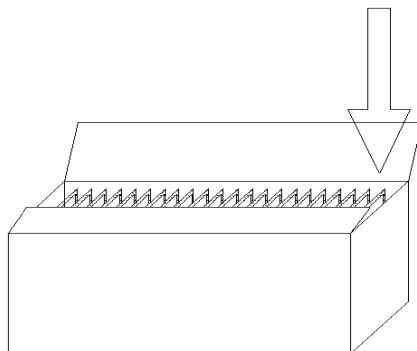

## 2.4 Reliability Test Items And Conditions

	9;			

## 2.5 Criteria For Judging Damage

	N			

## 3. SMT Reflow Soldering Instructions SMT 的 波 峰 焊

### 3.1 SMT Reflow Soldering Instructions



Repairing should not be done after the LEDs have been soldered. When repairing is unavoidable, a double-head soldering iron should be used (as below figure). It should be confirmed in advance whether the characteristics of LEDs will or not be damaged by repairing.

LED #w'@ D C ÉB \$ C . %o ûN± \$ C, , ûN± µ+^ j' J÷ ,6B J Á ~ Ê.µAÚ!š 0 ĩ E P C P • ...LED bDá°( ] >

### 3.1.3 Cautions # E ÁN<sup>-</sup>

(1) The encapsulated material of the LEDs is silicone. Therefore the LEDs have a soft surface on the top of package. The pressure to the top surface will be impacted on the reliability of the LEDs. Precautions should be taken to avoid the strong pressure on the encapsulated part. So when use the picking up nozzle, the pressure on the silicone resin should be proper. LED 7>û7, p.{ 7, ,>žM<sup>-</sup>

E¹Ež, +^ Ñ ? Á 7, %o>žM<sup>-</sup> P § LED %M- ], lš Ê ?N° Lh à óFµ f ^ ? Á ž, , %o µ+^ n j, , 7, %o>žM<sup>-</sup>, ° Á Ñ Ê e ! %o, ° >

(2) Components should not be mounted on warped (non coplanar) portion of PCB. After soldering, do not warp the circuit board. LED &¥\* C?.'@ Û ^ e ( , ° PCB µ @ , '@ Û • D , • C? . e Í4õ D%µ >

(3) Do not apply mechanical force or excess vibration during the cooling process to normal temperature after soldering. Do not rapidly cool device after soldering. #w'@ • D í aEý0A c , C?./ † Ī Ō Ö L Ñ , • C? . ?M= P , #w'@ D , C? . Gý+^%ö • í a , ° ĩ E >

## 4. Handling Pre caution s Ý ÷ µ+^# E ÁN<sup>-</sup>

### 4.1 Handli ng Preca utions Ý ÷ µ+^# E ÁN<sup>-</sup>

(1) LED operating environment and sulfur element composition cannot be over 100PPM in the LED mating usage material. This is provided for informational purposes only and is not a warranty or endorsement. LED ' )á ' D LED F8Gf, ° † Ī c. j y3V L > (Ý F 3 C %C » Eý100PPM. F e 6 ` 0Aä , C ' 1 < ÷ C^ û >

(2) In order to prevent external material from getting into the inside of LED, which may cause the malfunction of LED, the single content of Bromine element is required to be less than 900PPM, the single content of Chlorine element is required to be less than 900PPM, the total content of Bromine element and Chlorine element in the external materials of the application products is required to be less than 1500PPM. This is provided for informational purposes only and is not a warranty or endorsement. p ¼Lh ĩ L +, (ÝC^F ) LED »G FV F LED , ° Z , v : )á ' v+^ • , 1 • 1 • , < 6, ° \$ê y3V aH ? . "x E Ä 900PPM , < 6" e y3V aH ? . "x E Ä 900PPM , \$ê y3V D " e y3V q aH û N±E Ä 1500PPM. F e 6 ` 0Aä , C ' 1 < ÷ C^ û >

(3) VOCs (Volatile organic compounds) emitted from materials used in the construction of fixtures can penetrate silicone encapsulants of LEDs and discolor when exposed to heat and photonic energy. The result can be a significant loss of light output from the fixture. Knowledge of the properties of the materials selected to be used in the construction of fixtures can help prevent





optoelectronics  
玲涛光电

---



Ø ^		”	”
		”	”

p· p<sub>s</sub>

p· p<sub>s</sub>

