

# SPECIFICATION

# 产品规格书

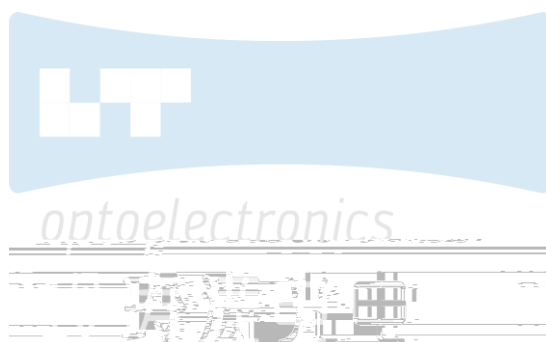

REFONDLT P/N 产品型号

RF-TVY\*SC33KCN

R&D 研发

Mass Product 量产供货

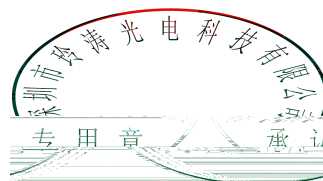

## Contents/ 目录

### 1. Description 产品介绍

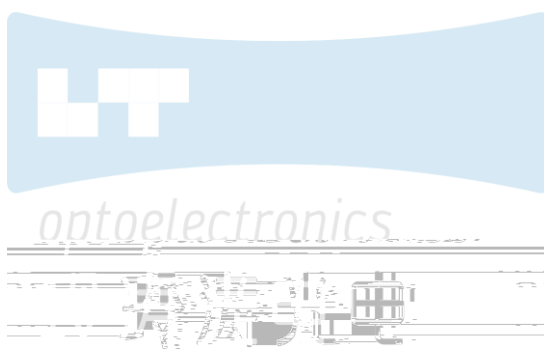

## 1. Description 产品介绍

### 1.1 Description 描述

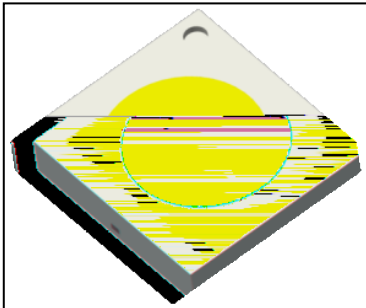

The White LED which was fabricated using a blue chip and the phosphor, outline size 3.0mm × 3.0mm × 0.60mm.

该产品为白光LED，是由蓝光芯片激发荧光粉而形成，产品尺寸：3.0mm × 3.0mm × 0.60mm。

#### 1.1.1 Features 特征

SMC Package. SMC 封装

Extremely wide viewing angle. 发光角度大

Suitable for all SMT assembly and solder process. 适用于所有的SMT组装和焊接工艺

Available on tape and reel. 适用于载带及卷轴

Moisture sensitivity level: Level 3. 防潮等级 Level 3

RoHS compliant. 满足RoHS要求

#### 1.1.2 Applications 应用

Backlight for LCD, TV or monitor. LCD背光、电视或显示器

Switch and symbol. 转换器、开关和标志

Optical indicator. 光学指示

Indoor display. 室内显示

Tubular light application. 用于日光灯管

General use. 其他应用

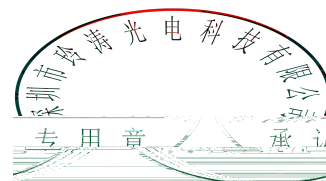

## 1.2 Package Dimension 产品尺寸

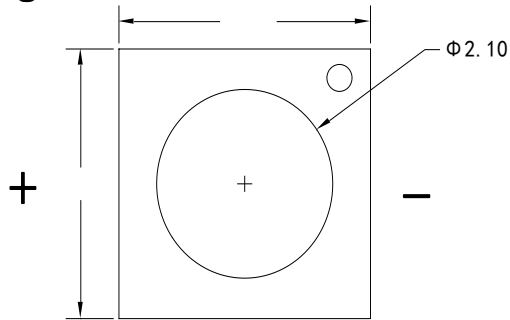

Fig.1-1 Top view 正面视图

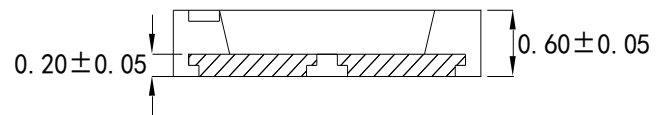

Fig.1-2 Side view 侧面视图

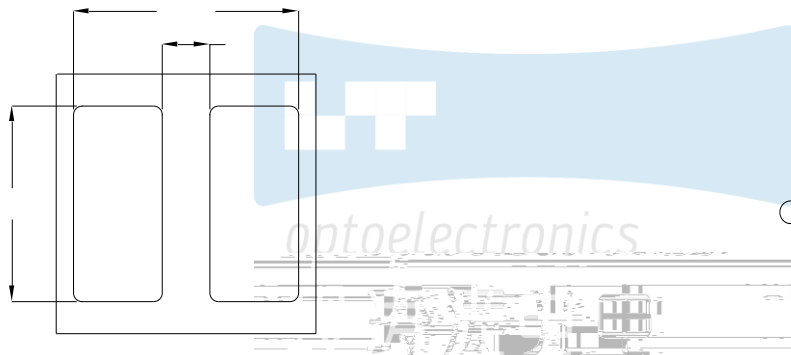

Fig.1-3 Bottom view 背面视图

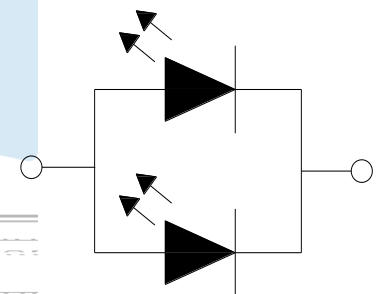

Fig.1-4 Polarity 极性

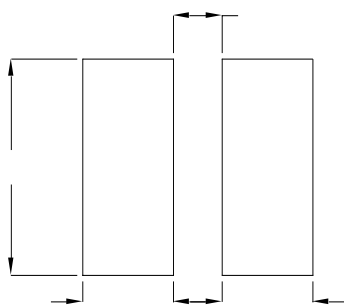
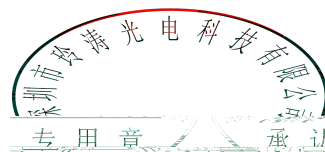

Fig.1-5 Soldering patterns 推荐焊盘

### Notes 备注

(1) All dimensions units are millimeters. 所有尺寸标注单位为毫米

(2) All dimensions tolerances are  $\pm 0.1$ mm unless otherwise noted. 除特别标注外, 所有尺寸公差为  $\pm 0.1$  毫米



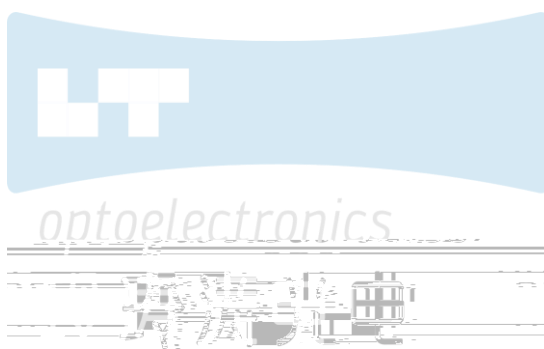

Notes 备注:

- (1) 1/10 Duty cycle, 0.1ms pulse width. 脉宽0.1ms,占空比1/10.
- (2) The above forward voltage measurement allowance tolerance is  $\pm 0.1V$ . 以上所示电压测量误差  $\pm 0.1V$ .
- (3) The above color coordinates measurement allowance tolerance is  $\pm 0.005$ . 以上所示坐标测量误差  $\pm 0.005$ .
- (4) The above luminous intensity measurement allowance tolerance  $\pm 5\%$ . 上述发光强度的测试允许公差为 $\pm 5\%$ .
- (5) Care is to be taken that power dissipation does not exceed the absolute maximum rating of the product. 使用功率不能超过规定的最大值。
- (6) All measurements were made under the standardized environment of Refond. 所有测试都是基于瑞丰现有的标准测试平台。
- (7) When the LEDs are in operation the maximum current should be decided after measuring the package temperature, junction temperature should not exceed the maximum rate. LED 使用的是大电流需要根据散热条件确定, 结温不能超过最大值。
- (8) ESD yield is over 90% at 2000V ESD (HBM). ESD protection during products handing is needed. 90%的LED 通过人体模式ESD2000V 测试, 在操作时请注意静电防护。

## 1.4 Bin Range Of Forward Voltage and Luminous Flux (IF=800mA)电压与流明分 BIN 范围(IF=800mA)

Table 1-3 Bin Range Of Forward Voltage and Luminous Flux电压与流明分BIN范围(IF=800mA)

VF V	G0	H0	I0	J0	K0	...	...	...
	2.8-3.0	3.0-3.2	3.2-3.4	3.4-3.6	3.6-3.8	...	...	...
Im	A200	A210	A220	A230	A240	A250	...	...
	200-210	210-220	220-230	230-240	240-250	250-260	...	...

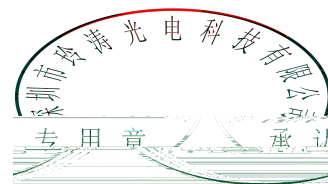

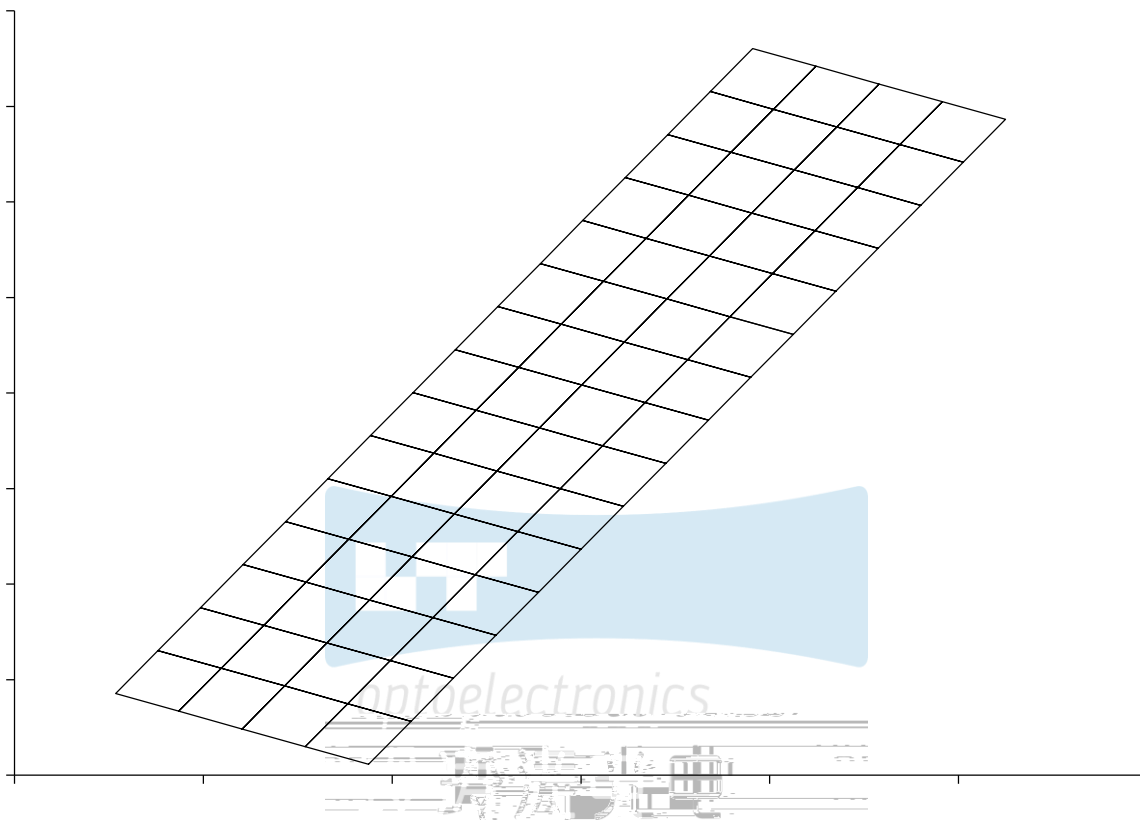

Fig 1-6 The C.I.E Chromaticity Diagram CIE色度图

Table 1-4 The C.I.E Chromaticity Diagram CIE色度图

BIN CODE	CIE-X1	CIE-Y1	CIE-X2	CIE-Y2	CIE-X3	CIE-Y3	CIE-X4	CIE-Y4
D00	0.3025	0.2723	0.2958	0.2760	0.3003	0.2850	0.3070	0.2813
D01	0.2980	0.2633	0.2913	0.2670	0.2958	0.2760	0.3025	0.2723
D02	0.2935	0.2543	0.2868	0.2580	0.2913	0.2670	0.2980	0.2633
D03	0.2890	0.2453	0.2823	0.2490	0.2868	0.2580	0.2935	0.2543
D04	0.2845	0.2363	0.2778	0.2400	0.2823	0.2490	0.2890	0.2453
D05	0.2800	0.2273	0.2733	0.2310	0.2778	0.2400	0.2845	0.2363
D06	0.2755	0.2183	0.2688	0.2220	0.2733	0.2310	0.2800	0.2273
D07	0.2710	0.2093	0.2643	0.2130	0.2688	0.2220	0.2755	0.2183
D08	0.2665	0.2003	0.2598	0.2040	0.2643	0.2130	0.2710	0.2093
D09	0.2620	0.1913	0.2553	0.1950	0.2598	0.2040	0.2665	0.2003
D10	0.2575	0.1823	0.2508	0.1860	0.2553	0.1950	0.2620	0.1913
D20	0.3070	0.2813	0.3003	0.2850	0.3048	0.2940	0.3115	0.2903
D21	0.3115	0.2903	0.3048	0.2940	0.3093	0.3030	0.3160	0.2993
D22	0.3160	0.2993	0.3093	0.3030	0.3138	0.3120	0.3205	0.3083
D23	0.3205	0.3083	0.3138	0.312	0.3183	0.321	0.325	0.3173

H00	0.2958	0.2760	0.2891	0.2797	0.2936	0.2887	0.3003	0.2850
H01	0.2913	0.2670	0.2846	0.2707	0.2891	0.2797	0.2958	0.2760
H02	0.2868	0.2580	0.2801	0.2617	0.2846	0.2707	0.2913	0.2670
H03	0.2823	0.2490	0.2756	0.2527	0.2801	0.2617	0.2868	0.2580
H04	0.2778	0.2400	0.2711	0.2437	0.2756	0.2527	0.2823	0.2490
H05	0.2733	0.2310	0.2666	0.2347	0.2711	0.2437	0.2778	0.2400
H06	0.2688	0.2220	0.2621	0.2257	0.2666	0.2347	0.2733	0.2310
H07	0.2643	0.2130	0.2576	0.2167	0.2621	0.2257	0.2688	0.2220
H08	0.2598	0.2040	0.2531	0.2077	0.2576	0.2167	0.2643	0.2130
H09	0.2553	0.1950	0.2486	0.1987	0.2531	0.2077	0.2598	0.2040
H10	0.2508	0.1860	0.2441	0.1897	0.2486	0.1987	0.2553	0.1950
H20	0.3003	0.2850	0.2936	0.2887	0.2981	0.2977	0.3048	0.2940
H21	0.3048	0.2940	0.2981	0.2977	0.3026	0.3067	0.3093	0.3030
H22	0.3071	0.3157	0.3026	0.3067	0.3093	0.3030	0.3138	0.3120
H23	0.3138	0.3120	0.3071	0.3157	0.3116	0.3247	0.3183	0.3210
K00	0.2891	0.2797	0.2824	0.2834	0.2869	0.2924	0.2936	0.2887
K01	0.2846	0.2707	0.2779	0.2744	0.2824	0.2834	0.2891	0.2797
K02	0.2801	0.2617	0.2734	0.2654	0.2779	0.2744	0.2846	0.2707
K03	0.2756	0.2527	0.2689	0.2564	0.2734	0.2654	0.2801	0.2617
K04	0.2711	0.2437	0.2644	0.2474	0.2689	0.2564	0.2756	0.2527
K05	0.2666	0.2347	0.2599	0.2384	0.2644	0.2474	0.2711	0.2437
K06	0.2621	0.2257	0.2554	0.2294	0.2599	0.2384	0.2666	0.2347
K07	0.2576	0.2167	0.2509	0.2204	0.2554	0.2294	0.2621	0.2257
K08	0.2531	0.2077	0.2464	0.2114	0.2509	0.2204	0.2576	0.2167
K09	0.2486	0.1987	0.2419	0.2024	0.2464	0.2114	0.2531	0.2077
K10	0.2441	0.1897	0.2374	0.1934	0.2419	0.2024	0.2486	0.1987
K20	0.2936	0.2887	0.2869	0.2924	0.2914	0.3014	0.2981	0.2977
K21	0.2981	0.2977	0.2914	0.3014	0.2959	0.3104	0.3026	0.3067
K22	0.3004	0.3194	0.2959	0.3104	0.3026	0.3067	0.3071	0.3157
K23	0.3071	0.3157	0.3004	0.3194	0.3049	0.3284	0.3116	0.3247
T00	0.2824	0.2834	0.2757	0.2871	0.2802	0.2961	0.2869	0.2924
T01	0.2779	0.2744	0.2712	0.2781	0.2757	0.2871	0.2824	0.2834
T02	0.2734	0.2654	0.2667	0.2691	0.2712	0.2781	0.2779	0.2744
T03	0.2689	0.2564	0.2622	0.2601	0.2667	0.2691	0.2734	0.2654
T04	0.2644	0.2474	0.2577	0.2511	0.2622	0.2601	0.2689	0.2564
T05	0.2599	0.2384	0.2532	0.2421	0.2577	0.2511	0.2644	0.2474
T06	0.2554	0.2294	0.2487	0.2331	0.2532	0.2421	0.2599	0.2384
T07	0.2509							



## 1.5 Typical optical characteristics curves 典型光学特性曲线

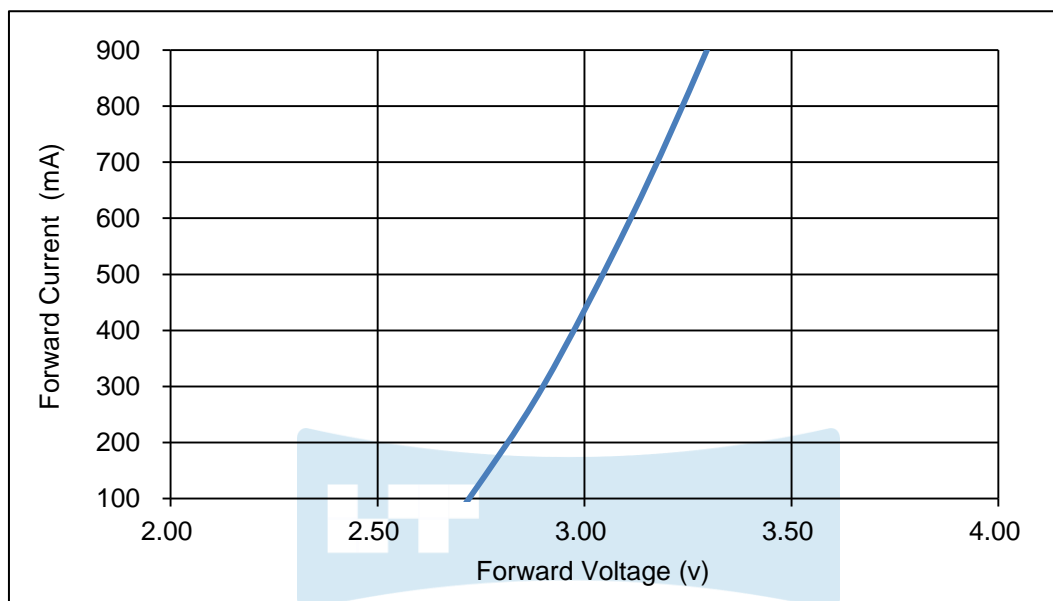

Fig 1-7 Forward Voltage Vs. Forward Current 伏安特性曲线

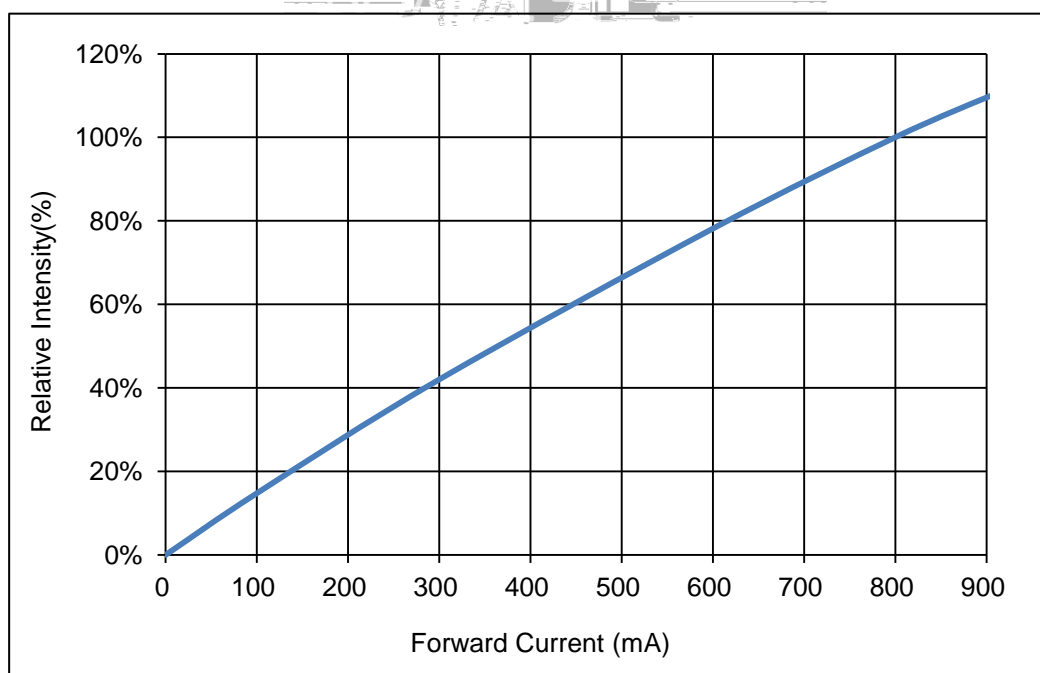

Fig 1-8 Forward Current Vs. Relative Intensity 正向电流与相对光强特性曲线



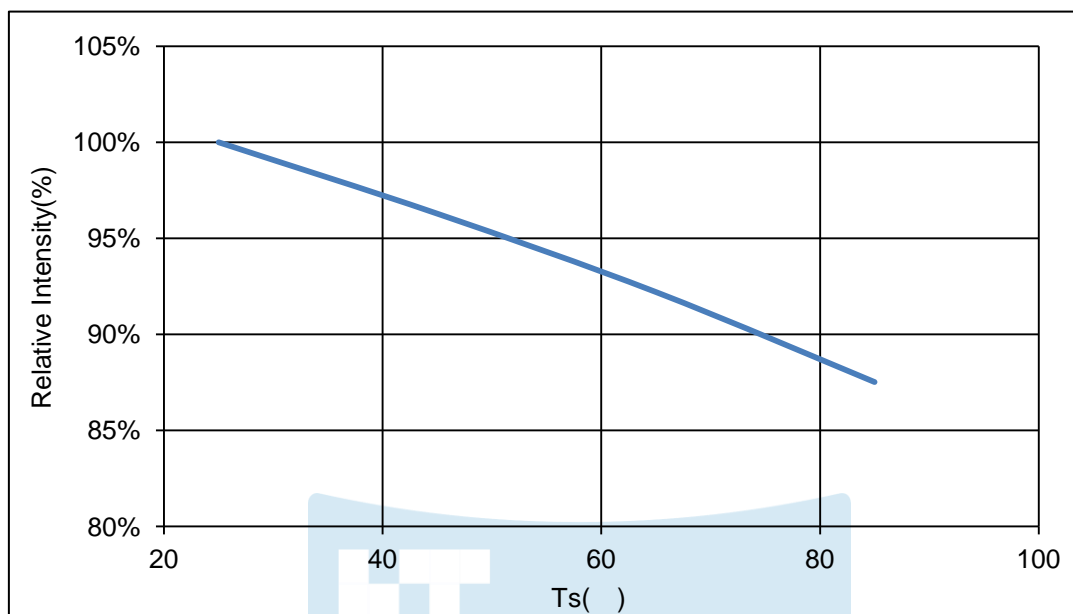

Fig 1-9 Solder Temperature Vs Relative Intensity 管脚温度与相对光强特性曲线

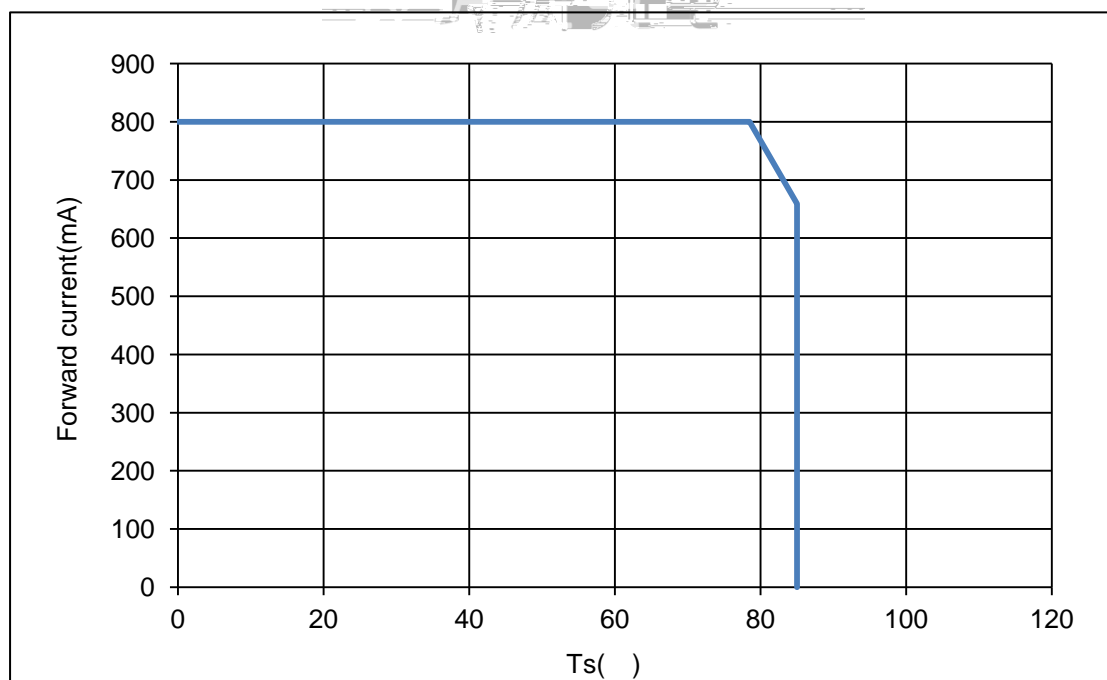
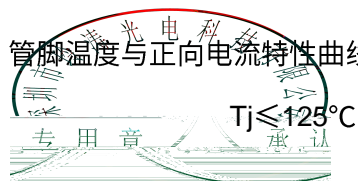

Fig 1-10 Solder Temperature Vs Forward Current 管脚温度与正向电流特性曲线



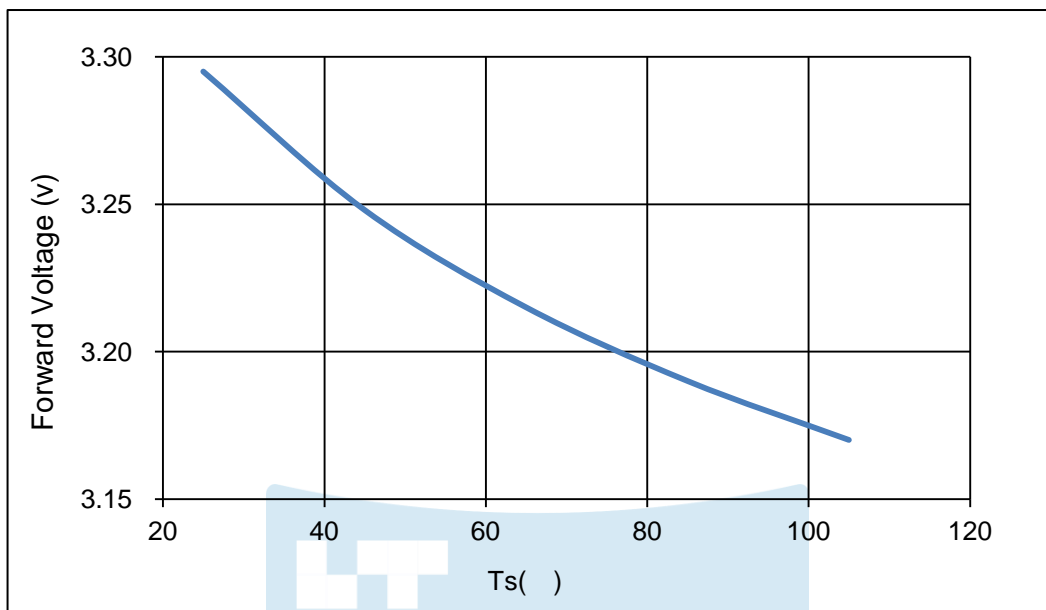

Fig 1-11 Forward Voltage Vs Solder Temperature 电压与管脚温度特性曲线

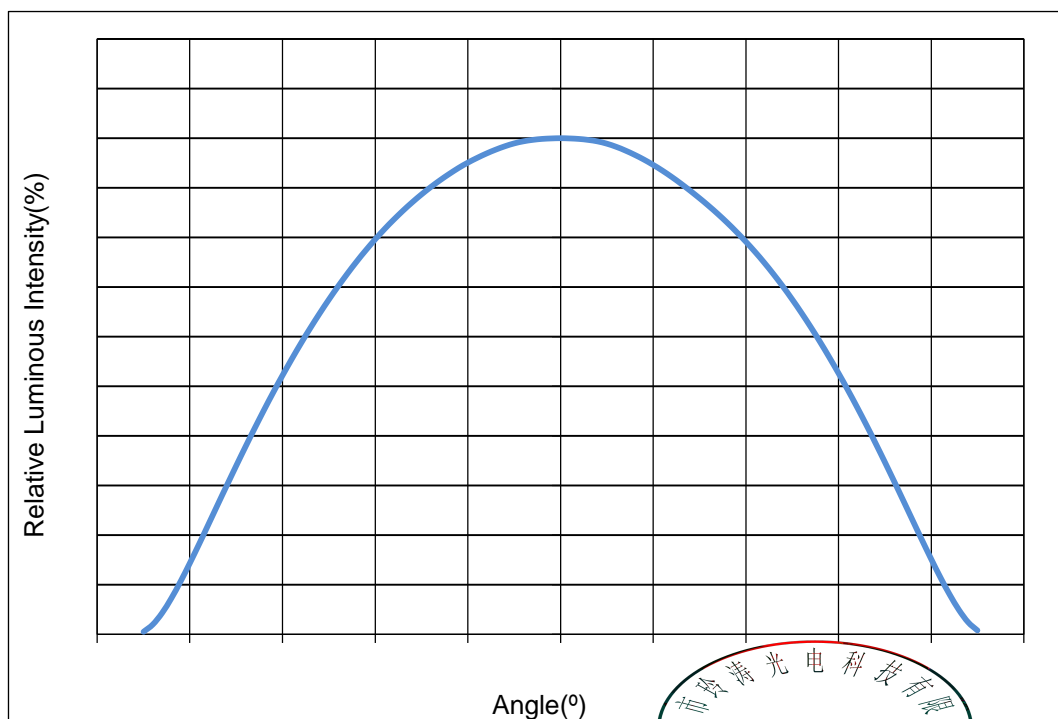

Fig 1-12 Radiation diagram 辐射特性曲线

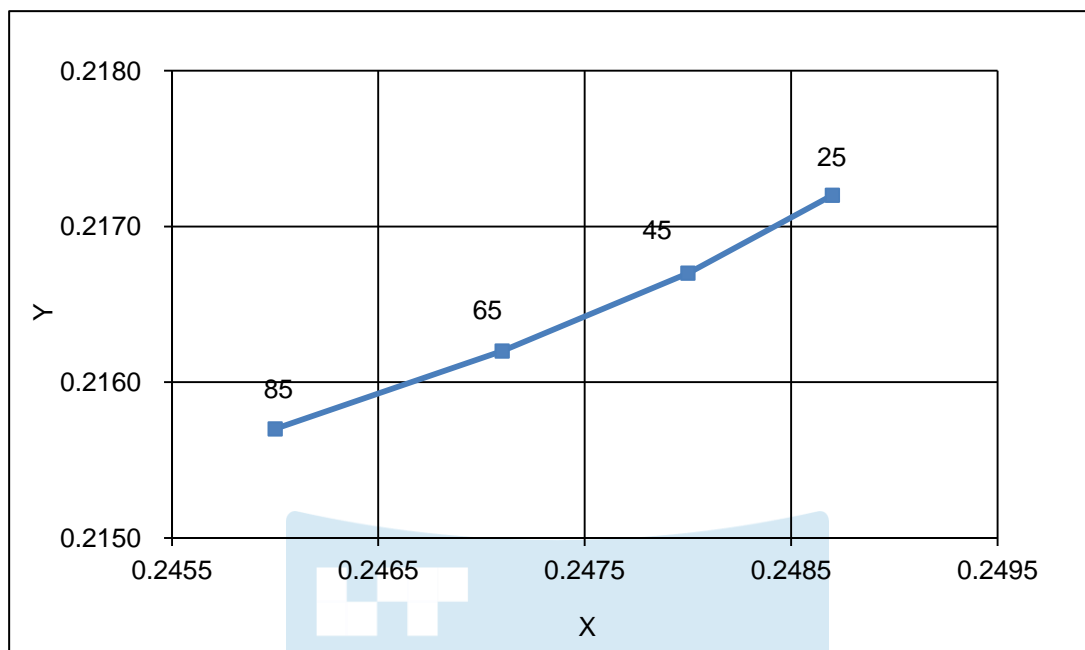

Fig 1-13 Chromaticity Coordinate Vs Solder Temperature 色坐标与管脚温度特性曲线

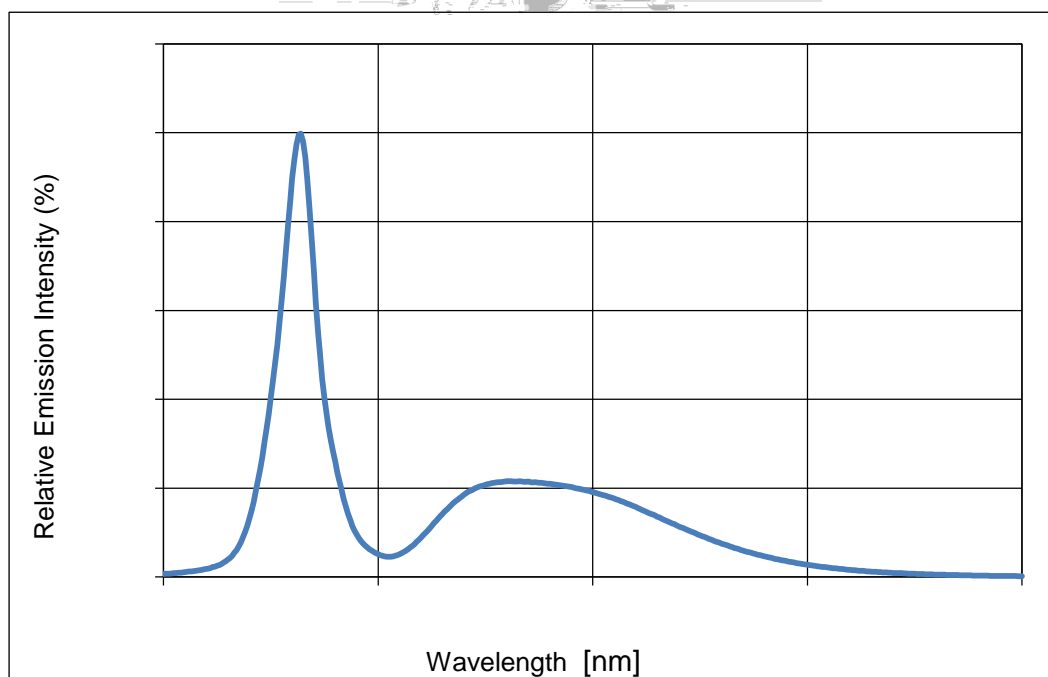
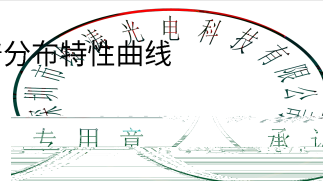

Fig.8- Spectrum Distribution 光谱分布特性曲线



## 2. Packaging 产品包装

### 2.1 Packaging Specifications 包装规格

Package:5000pcs/reel.包装每卷5000pcs

#### 2.1.1 Carrier Tape Dimensions 载带尺寸

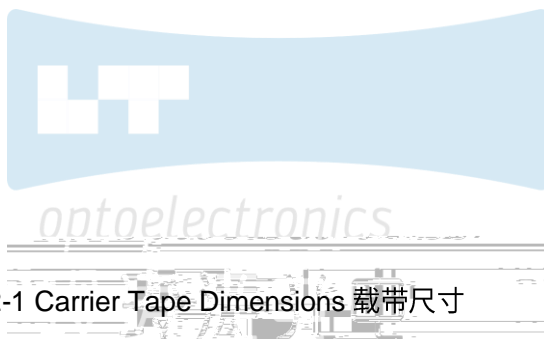

Fig 2-1 Carrier Tape Dimensions 载带尺寸

#### 2.1.2 Reel Dimension 卷盘尺寸

Table 2-1 Reel Dimension 卷盘尺寸

A	16.9±0.1mm
B	178±1mm
C	5JETQq383.35 3

Fig 2-2 Reel Dimension 卷盘尺寸

#### NOTES 备注:

The tolerances unless mentioned  $\pm 0.1\text{mm}$ . Unit : mm 注: 未注公差为 $\pm 0.1$ 毫米, 尺寸单位: 毫米。

### 2.1.3 Label Form Specification 标签规格

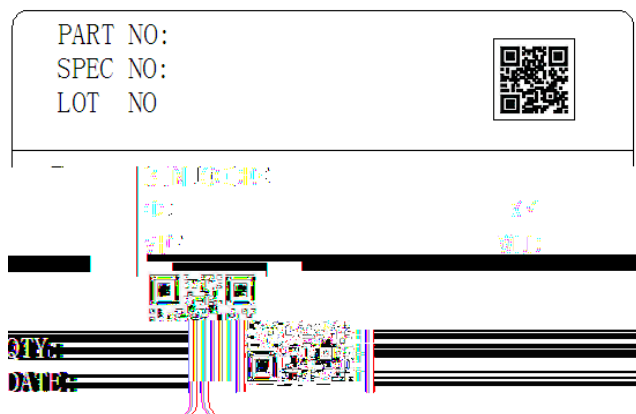

Fig 2-3 Label Form Specification 标签规格

Table 2-2 Label Form Specification 标签规格

PART NO.	Part Number	品名
SPEC NO.	Spec Number	规格
LOT NO.	Lot Number	批次号
BIN CODE	Bin Code	参数代码
	Luminous flux	光通量
XY	Chromaticity Bin	色区
VF	Forward Voltage	正向电压
WLD	Wavelength	波长代码
QTY	Packing Quantity	数量
DATE	Made Date	生产日期

### 2.1.4 Moisture Resistant Packing Process 防潮包装过程

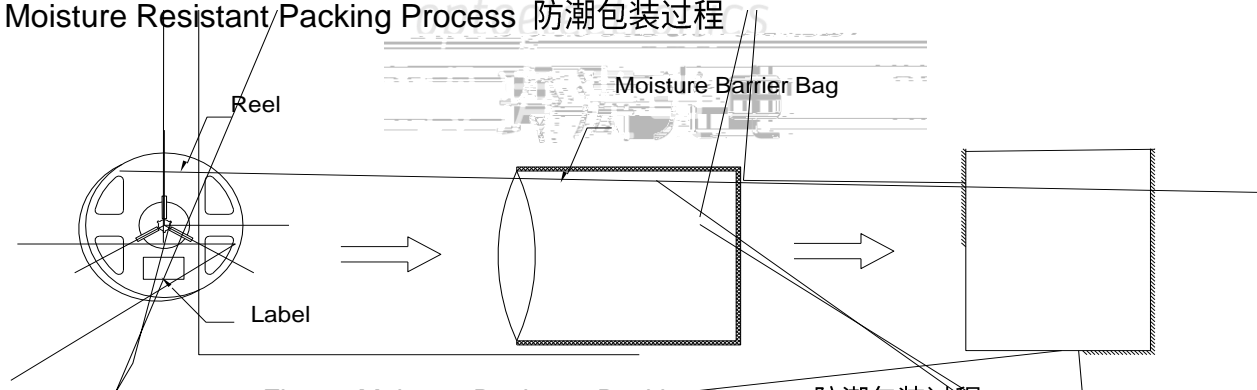

Fig 2-4 Moisture Resistant Packing Process 防潮包装过程

### 2.1.5 Cardboard Box 纸箱

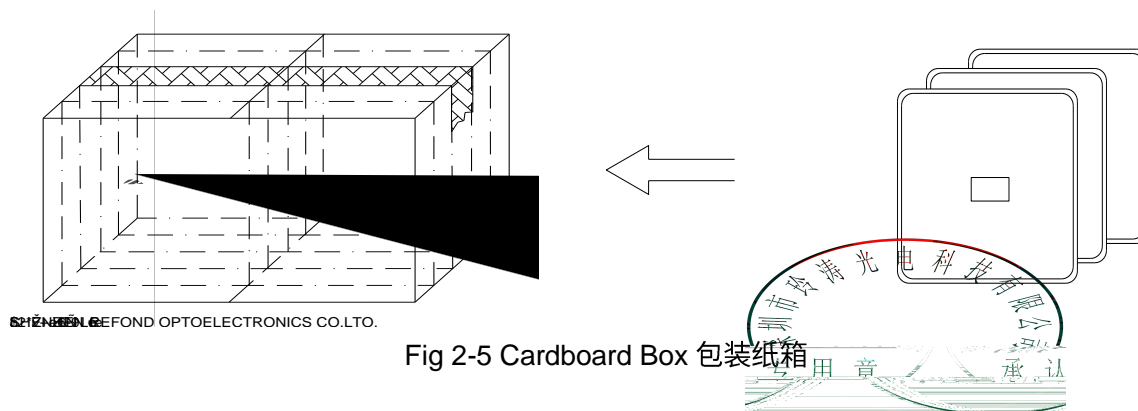
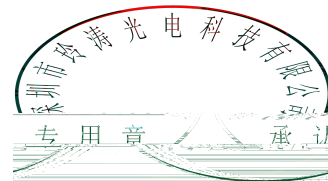

Fig 2-5 Cardboard Box 包装纸箱

## 2.1.6 Reliability Test Items And Conditions 信赖性测试项目及条件

Table 2-3 Reliability Test Items And Conditions 信赖性测试项目及条件

Test Items 项目	Ref.Standard 参考标准	Test Condition 测试条件	Time 时间	Quantity 数量	Ac/Re 接收/拒收
Reflow 回流焊	JESD22-B106	Temp:260°Cmax T=10 sec	2times	20Pcs	0/1
Thermal Shock 冷热冲击	JEITAED-4701 300 307	-40°C 15min 10s 100°C 15min	100 cycle	20Pcs	0/1
High Temperature Storage 高温保存	JEITAED-4701 200 201	Temp:100°C	1000Hrs	20Pcs	0/1
Low Temperature Storage 低温保存	JEITA ED-4701 200 202	Temp:-40°C	1000Hrs	20Pcs	0/1
Life Test 常温通电	JESD22-A108	T <sub>A</sub> =25°C I <sub>F</sub> =800mA	1000Hrs	10Pcs	0/1
High Temperature High Humidity Life Test 高温高湿通电	JESD22-A101	60°C/ 90%RH I <sub>F</sub> =800mA	500Hrs	10Pcs	0/1



## 2.1.7 Criteria For Judging Damage 失效判定标准

Table 2-4 Criteria For Judging Damage 失效判定标准

Test Items 项目	Symbol 符号	Test Condition 测试条件	Criteria For Judgement 判定标准	
			Min. 最小	Max. 最大
Forward Voltage 正向电压	$V_F$	$I_F=800mA$	-	U.S.L*)x1.1
Reverse Current 反向电流	$I_R$	$V_R = 5V$	-	U.S.L*)x2.0
Luminous Flux 光通量		$I_F=800mA$	L.S.L*)x0.7	-

### NOTES 备注:

(1) U.S.L: Upper standard level 规格上限 L.S.L: Lower standard level 规格下限

(2) The above reliability tests is based on the verification of a single/strip LED of Refond's existing experimental platform, the reliability experiment was taken under good heat dissipation conditions. when customers appliesthe LED to the series and parallel circuit, should take consideration of all the factors such as the current, voltage distribution, heat dissipation and others. 以上可靠性测试是基于瑞丰现有实验平台单颗/条LED在良好散热条件验证下的结果。客户端将LED应用于串、并联线路时，需自行评估电流、电压分配、散热等问题。

(3) The technical information shown in the data sheets are limited to the typical characteristics and circuit examples of the referenced products. It does not constitute the warranting of industrial property nor the granting of any license. 以上技术数据仅为产品的典型值，只作为参考，不作为任何应用条件及应用方式的保证。

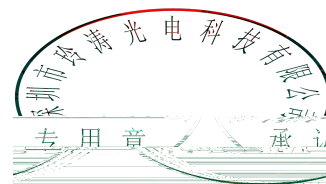



### 3. SMT Reflow Soldering Instructions SMT回流焊说明

Fig 3-1 3. SMT Reflow Soldering Instructions SMT 回流焊说明

Table 3-1 SMT Reflow Soldering Instructions SMT 回流焊说明

Average temperature rise speed平均升温速度 (T <sub>smax</sub> 至T <sub>P</sub> )	最高3 °C/秒 Max 3 °C/ s
Preheating: minimum temperature预热: 最低温度 (T <sub>smin</sub> )	150 °C
Preheating: Max temperature预热: 最高温度 (T <sub>smax</sub> )	200 °C
Preheating: Time预热: 时间 (T <sub>smin</sub> 至T <sub>smax</sub> )	60 - 120秒 60s-120s
Time limited to maintain high temperature: the temperature限时维持高温: 温度 (T <sub>L</sub> )	217 °C
Time limited to maintain high temperature: The Time 限时维持高温: 时间 (t <sub>L</sub> )	最多60秒 Max 60s
Peak /Classification of temperature:峰值 / 分类温度 (T <sub>P</sub> )	260 °C

Time limit classification of T0 1 275.521.63.039 523.9 12.984 69JETQq33.36 302.8'

NOTES 备注:

(1) Reflow soldering should not be done more than two times. In the case of more than JE73o done more (m)-7(ore )7(t

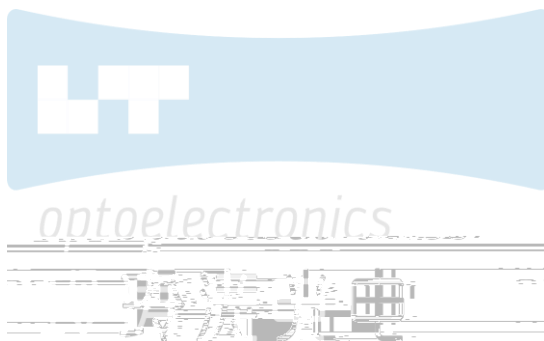

## 4. Handling Precautions 使用注意事项

(1) LED

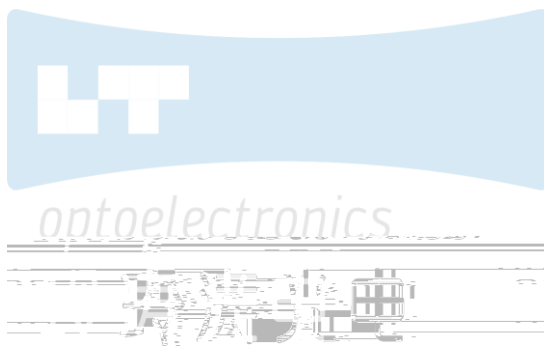

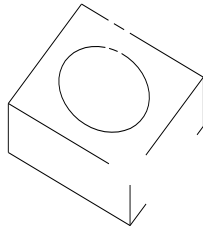
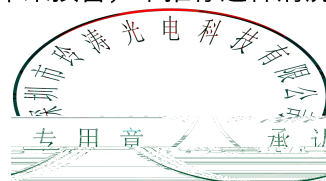

Fig 4-1

(5) In designing a circuit, the current through each LED can not be exceed the absolute maximum rating specified for each LED. In the meanwhile, resistors for protection should be applied, otherwise slight voltage shift will cause big current change, burn out may happen. The driving circuit must be designed to allow forward voltage only when it is ON or OFF. If the reverse voltage is applied to LED, migration can be generated resulting in LED damage. 设计电路时，通过 LED 的电流不能超过规定的最大值。同时，还需使用保护电阻，否则，微小的电压变化将会引起较大电流变化，可能导致产品损毁。电路设计必须保证只有在开启或者关闭的时候出现正向电压的变化，不要施加反压，否则会损坏 LED。

(6) Thermal Design is paramount importance because heat generation may result in the Characteristics decline, such as brightness decreased, Color change and so on. Please consider the heat generation of the LEDs when making the system design. LED 发光效率，影响发光颜色，所以在设计时应充分考虑散热问题。

(7) Compared to standard encapsulants, silicone is generally softer, and the surface is more likely to attract dust, requiring special care during processing. In cases where a minimal level of dirt and dust particles cannot be guaranteed, a suitable cleaning solution must be applied to the surface after the soldering of components. Refond suggests using isopropyl alcohol for cleaning. In case other solvents are used, it must be assured that these solvents do not dissolve the package or resin. Ultrasonic cleaning is not recommended. Ultrasonic cleaning may cause damage to the LED. 与其他封装胶相比，硅胶通常较软，表面易吸附颗粒，应用时应特别注意，当对产品洁净度要求较高时，回流焊以后需要采用恰当的清洗方式，我们推荐用异丙醇作清洗剂，如需要用到其他清洗剂，必须保证不会破坏封装体，超声清洗可能会对 LED 带来损害，不推荐这种清洗方式。



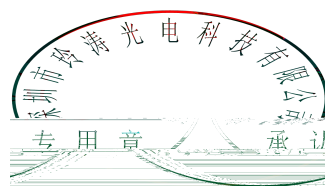
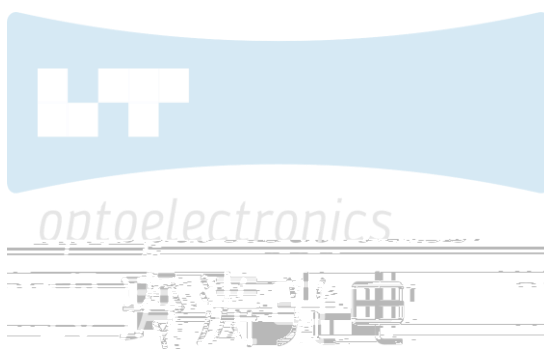

---

2019-12-18

黄承斌

E7

刘娟

修正尺寸公差及  
ESD 备注

