

SPECIFICATION

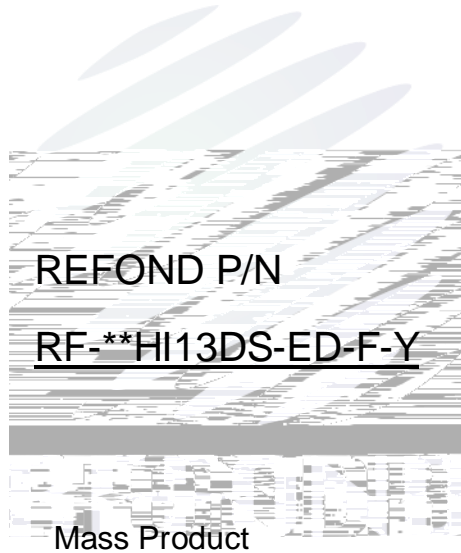

Contents

1. Description		3
1.1 General Description		3
1.2 Features		3
1.3 Application		3
1.4 Package Dimension		4
1.5 Product Parameters		5
1.6 Bin Range Of Forward Voltage and Luminous Flux (IF=30mA)	BIN	
(IF=30mA)		7
1.7 Typical optical characteristics curves		9
2. Packaging		12
2.1 Packaging Specification		12
2.2 Moisture Resistant Packing		14
2.3 Cardboard Box		14
2.4 Reliability Test Items And Conditions		15
2.5 Criteria For Judging Damage		16
3. SMT Reflow Soldering Instructions SMT		17
3.1 SMT Reflow Soldering Instructions SMT		17
4. Handling Precautions		19
4.1 Handling Precautions		19

1. Description

1.1

The White LED which was fabricated using a blue chip and the phosphor.

Dimension :3.0mmX1.4mmX0.7mm.

DC

3.0mmX1.4mmX0.7mm

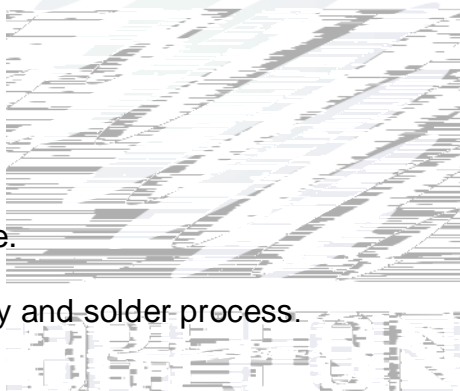

1.2 Features

PLCC Package. O

Extremely wide viewing angle.

Suitable for all SMT assembly and solder process.

Available on tape and reel.

Moisture sensitivity level: Level 3.

RoHS compliant.

1.3 Application

Hotels,markets,offices,household and other indoor uses.

Optical indicator.

L

2

1.4 Package Dimension

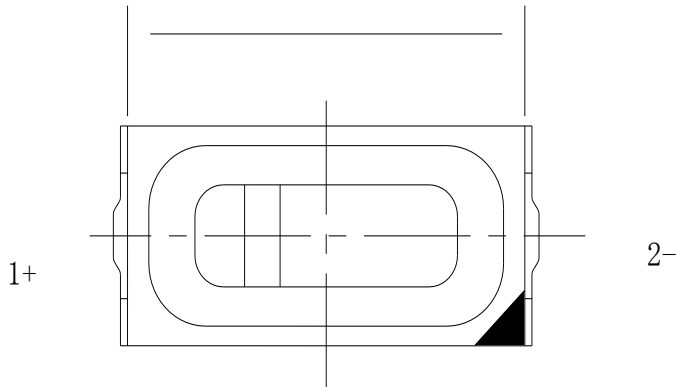

Fig.1-1 Top view

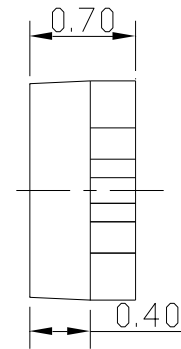

Fig.1-2 Side view

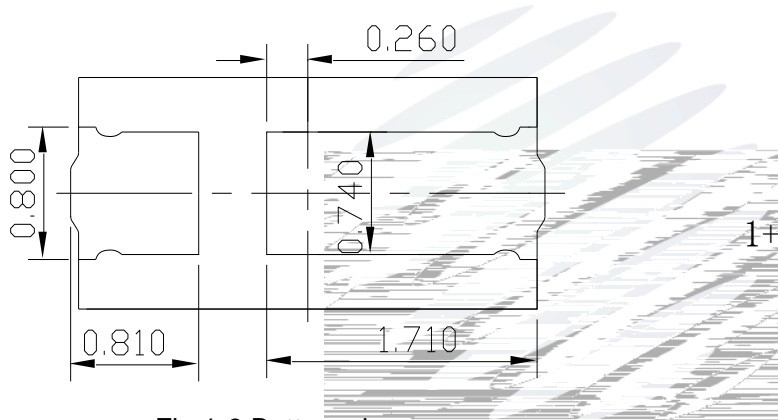

Fig.1-3 Bottom view

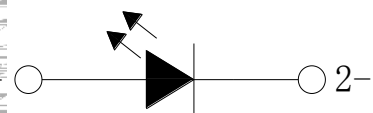

Fig.1-4 Polarity

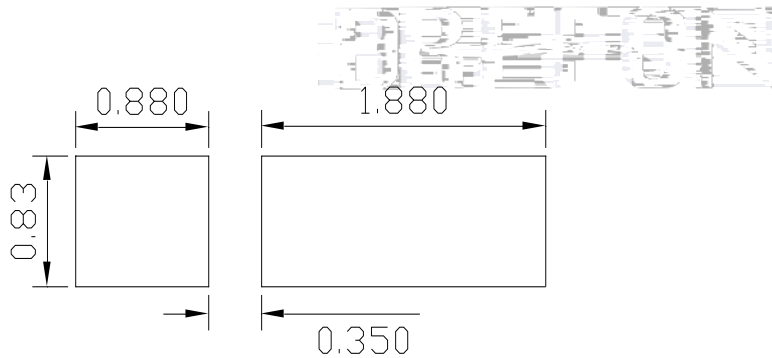

Fig.1-5 Soldering patterns

Notes

All dimensions units are millimeters.

All dimensions tolerances are $\pm 0.2\text{mm}$ unless otherwise noted.

/ -1

1.5 Product Parameters

Table 1-1 Electrical / Optical Characteristics at Ts=25°C

Item	Symbol	Test Condition	Value			Unit
			Min.	Typ	Max.	
Forward Voltage	V_F	$I_F=30mA$	2.7	---	3.3	V
Reverse Current	I_R	$V_R=5V$	---	---	10	μA
Luminous Flux		$I_F=30mA$	10	---	15	lm
Viewing Angle	2 1/2	$I_F=30mA$	---	120	---	deg
Color Rendering Index (显色指数)	R_a	$I_F=30mA$	80	---	---	---
Thermal Resistance.	R_{THJ-S}	$I_F=30mA$	---	66	---	$^{\circ}C/W$

Table 1-2 Absolute Maximum Ratings at Ts=25°C

Parameter	Symbol	Rating	Units
Power Dissipation	P_D	132	mW
Forward Current	I_F	40	mA
Peak Forward Current	I_{FP}	100	mA
Reverse Voltage	V_R	5	V
Electrostatic Discharge (HBM)	E_{SD}	2000	V
Operating Temperature	T_{OPR}	-40 ~ +85	$^{\circ}C$
Storage Temperature	T_{OPR}	-40 ~ +85	$^{\circ}C$
Junction Temperature	T_J	91	$^{\circ}C$

Notes

1. 1/10 Duty cycle, 0.1ms pulse width. / -0 0.0/ -
2. The above forward voltage measurement allowance tolerance is $\pm 0.1V$.
3. The above color coordinates measurement allowance tolerance is ± 0.005 . $\pm / - / / 4-$
4. The above luminous intensity measurement allowance tolerance $\pm 10\%$.
5. The above color rendering index measurement allowance is 1. Ra 1
6. Care is to be taken that power dissipation does not exceed the absolute maximum rating of the product.
7. All measurements were made under the standardized environment of Refond.
8. When the LEDs are in operation the maximum current should be decided after measuring the package temperature junction temperature should not exceed the maximum rate- DC

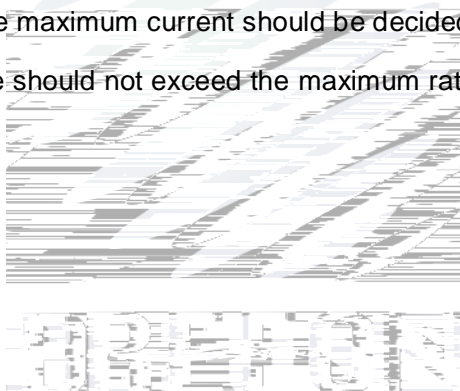

1.6 Bin Range Of Forward Voltage and Luminous Flux (IF=30mA)

BIN (IF=30mA)

Table 1-3

V _F (V)	F2	G1	G2	H1	H2	I1
	2.7-2.8	2.8-2.9	2.9-3	3-3.1	3.1-3.2	3.2-3.3
RF-27HI13DS-ED-F-Y (Lm)	OGA	OHA	PEA	PFA	PGA	
	10-11	11-12	12-13	13-14	14-15	
RF-30HI13DS-ED-F-Y (Lm)	A10	A20	P03	P04	/	
	8-10	10-12	12-14	14-16	/	
RF-35HI13DS-ED-F-Y (Lm)	OGA	OHA	PEA	PFA	PGA	
	10-11	11-12	12-13	13-14	14-15	
RF-E40HI13DS-ED-F-Y (Lm)	OGA	OHA	PEA	PFA	PGA	
	10-11	11-12	12-13	13-14	14-15	
RF-60HI13DS-ED-F-Y (Lm)	A10	A20	P03	P04	/	
	8-10	10-12	12-14	14-16	/	
RF-65HI13DS-ED-F-Y (Lm)	OGA	OHA	PEA	PFA	PGA	
	10-11	11-12	12-13	13-14	14-15	



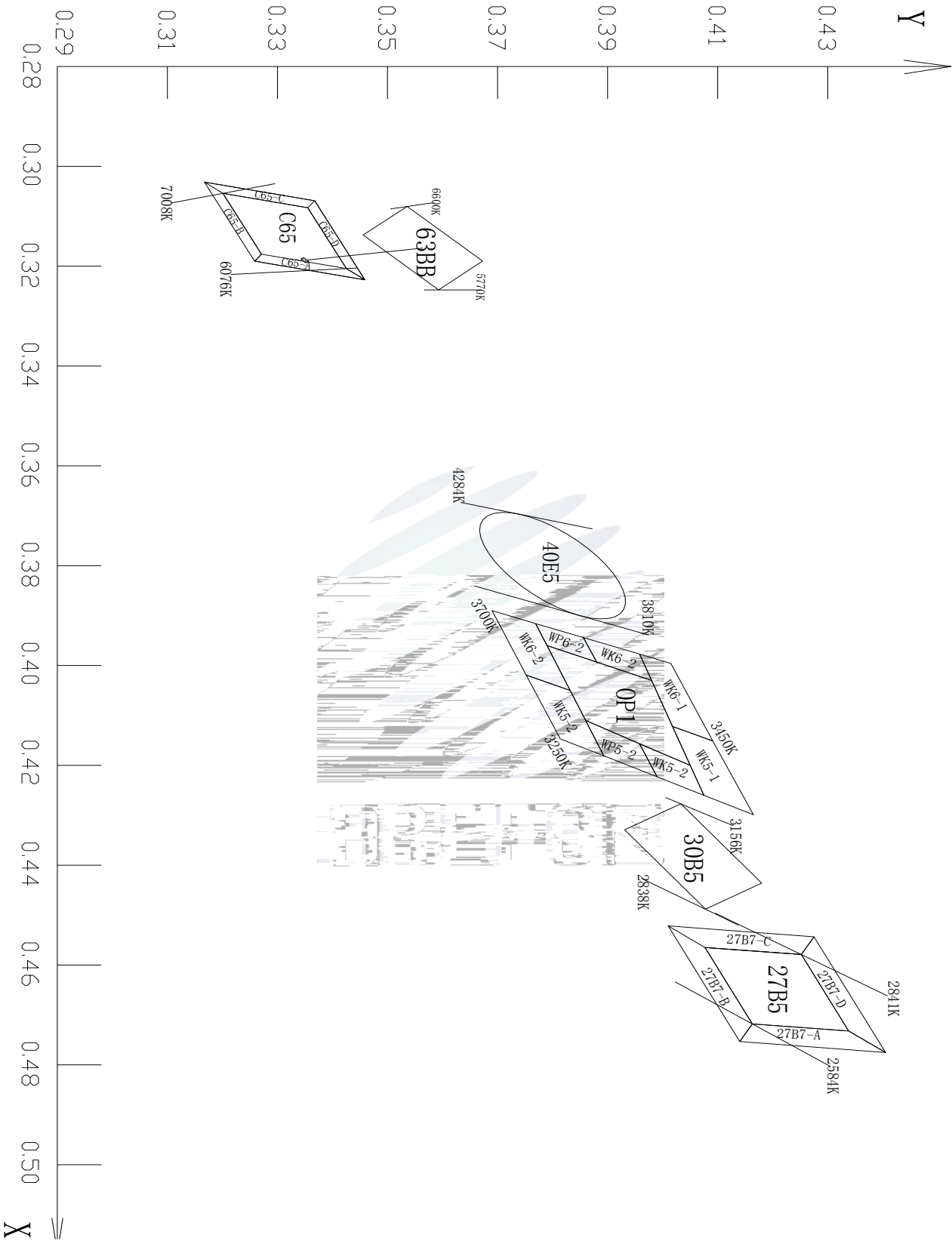

Fig 1-6 The C.I.E Chromaticity Diagram CIE

1.7 Typical optical characteristics curves

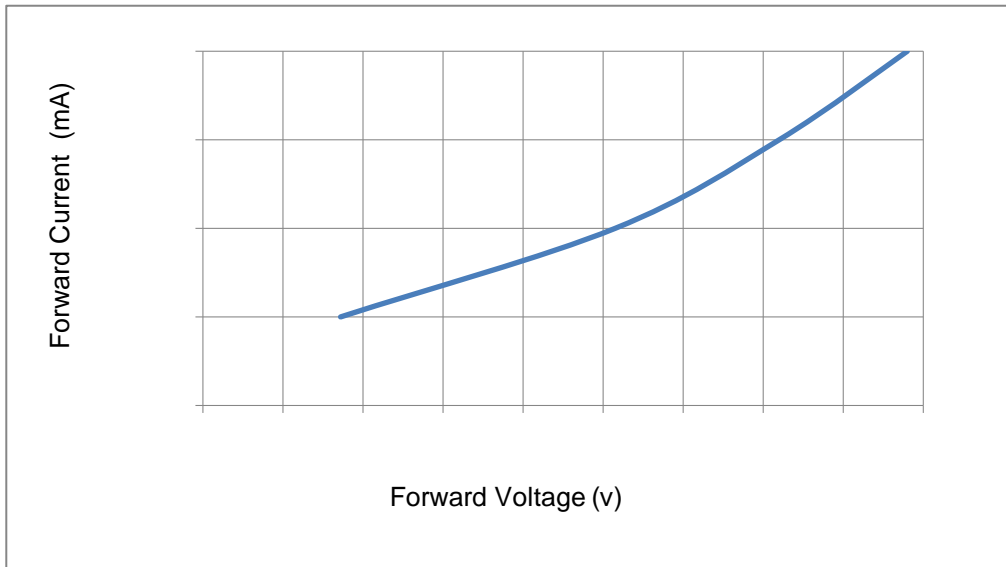

Fig 1-7 Forward Voltage Vs. Forward Current

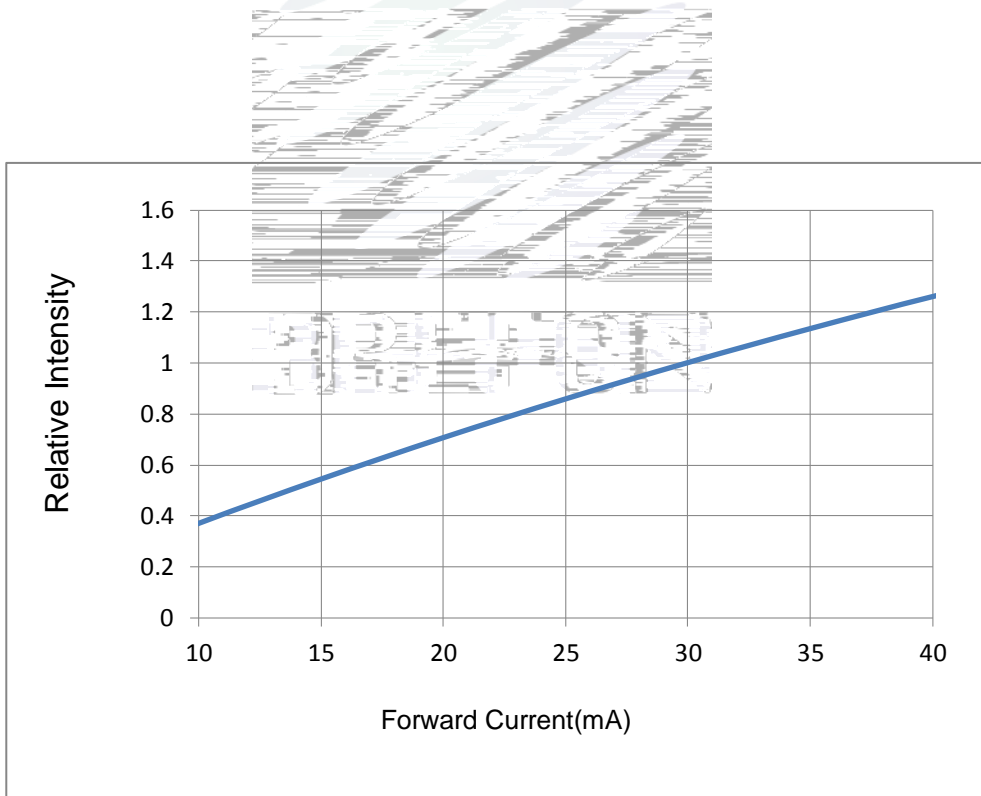
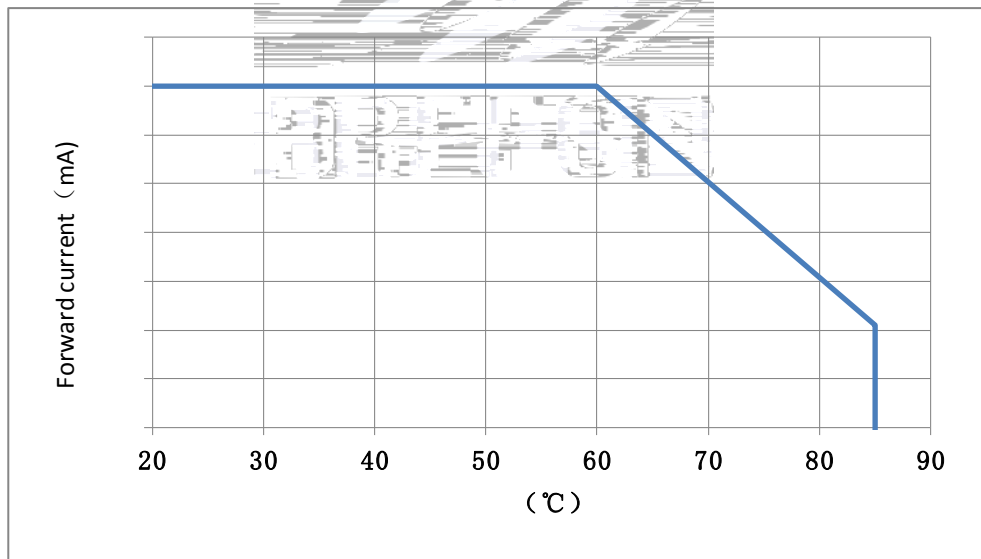

Fig 1-8 Forward Current Vs. Relative Intensity

Fg151 ID 10 0 01.27 475q293.27 47549(127 475.83 Tm[g151 ID 3D 001.27 475q-27 475.83 Tm[g151 ID



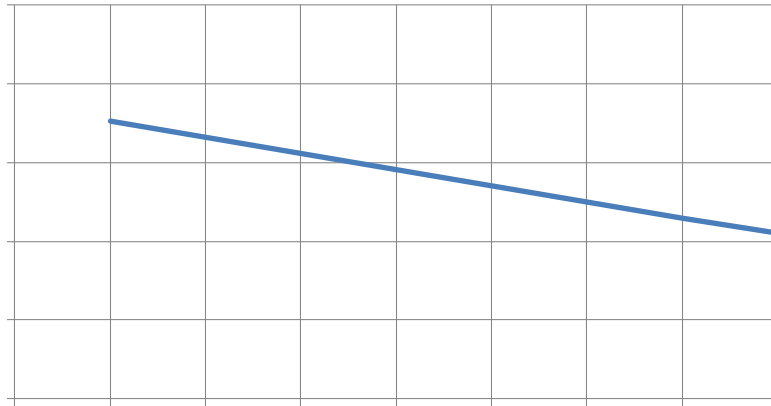

Fig 1-11 Forward Voltage Vs Solder Temperature

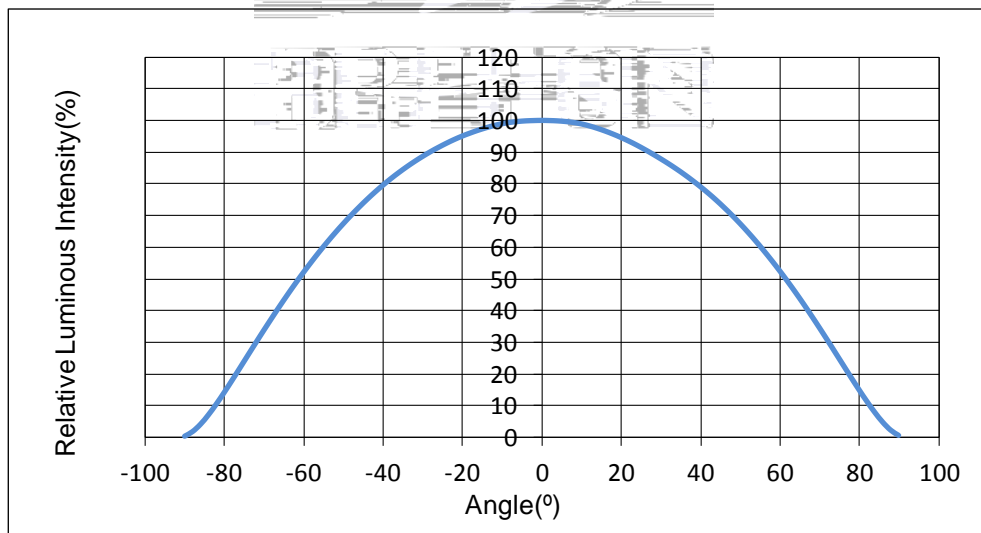

Fig 1-12 Radiation diagram

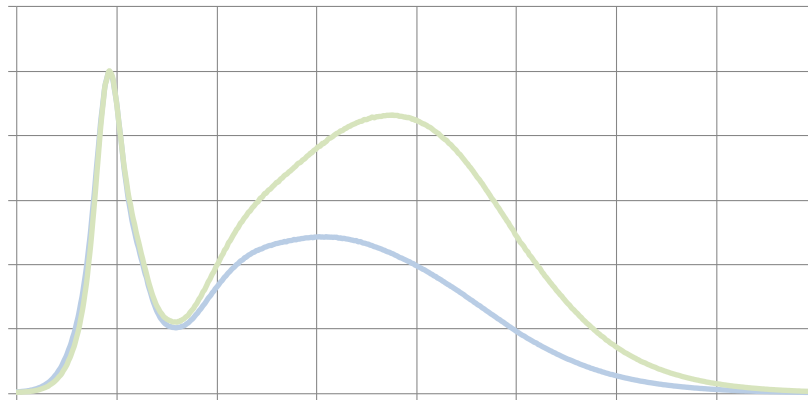

Fig 1-13 Spectrum Distribution



2. Packaging

2.1 Packaging Specification

Package: Max 4000pcs/reel I. 4000pcs

2.1.1 Carrier Tape Dimension

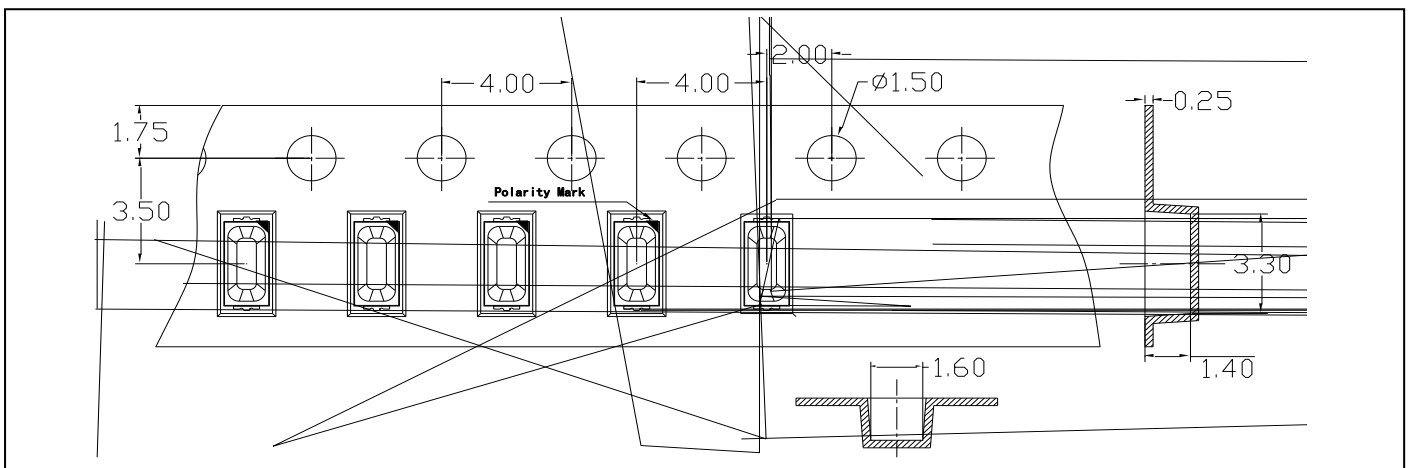

Fig.2-1 Carrier Tape Dimension

2.1.2 Reel Dimension

1,0

A	11.7 0.1mm
B	178 1mm
C	60 1mm
D	13.5 0.5mm

Fig.2-2

Notes

The tolerances unless mentioned ± 0.1 mm. Unit : mm ± 0.1

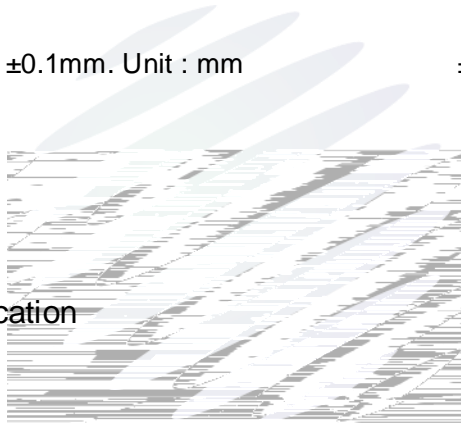

2.1.3 Label Form Specification

1,1

PART NO.
SPEC
LOT NO.
BIN CODE



PART NO.	Part Number
SPEC NO.	Spec Number
LOT NO.	Lot Number
BIN CODE	Bin Code
	Luminous flux
XY	Chromaticity Bin
V _F	Forward Voltage
QTY	Packing Quantity
DATE	Made Date



2.4 Reliability Test Items And Conditions

Table 2-3 Test items and conditions

Test Items	Ref.Standard	Test Condition	Time	Quantity	Ac/Re /
Reflow	JESD22-B106	Temp:260 max T=10 sec	2times	10pcs	0/1
Thermal Shock	JEITAED-4701 300 307	-40 15min 10s 100 15min	300 cycle	10pcs	0/1
High Temperature Storage	JEITAED-4701 200 201	Temp:100	1000hrs	10pcs	0/1
Low Temperature Storage	JEITA ED-4701 200 202	Temp:-40	1000hrs	10pcs	0/1
Life Test	JESD22-A108	Ta=25 If=30mA	1000hrs	10pcs	0/1
High Temperature High Humidity Life Test	JESD22-A101	60 / 90%RH If=30mA	500hrs	10pcs	0/1

2.5 Criteria For Judging Damage

Table 2-4 Criteria for judging damage

Test Items	Symbol	Test Condition	Criteria For Judgement	Applicable project
Forward Voltage	V_F	H 2/	0/	Reflow Thermal Shock
Luminous Flux		H 2/	Maintenance 90% 90%	High and Low Temperature Storage Life Test
Lamp Bead Light Test	.	H 2/	No open circuit short circuit or flicke	High Temperature High Humidity Life Test

Notes

1.U.S.L: Upper standard level

L.S.L: Lower standard level

2.The above reliability tests are based on the verification of a single/strip LED of Refond's existing experimental platform,the reliability experimental was taken under good heat dissipation conditions.When customers applies the LED to the series and parallel circuit,should take consideration of all the factors such as the current,voltage distribution,heat dissipation and others.

DC

DC

3. SMT Reflow Soldering Instructions SMT

3.1 SMT Reflow Soldering Instructions SMT

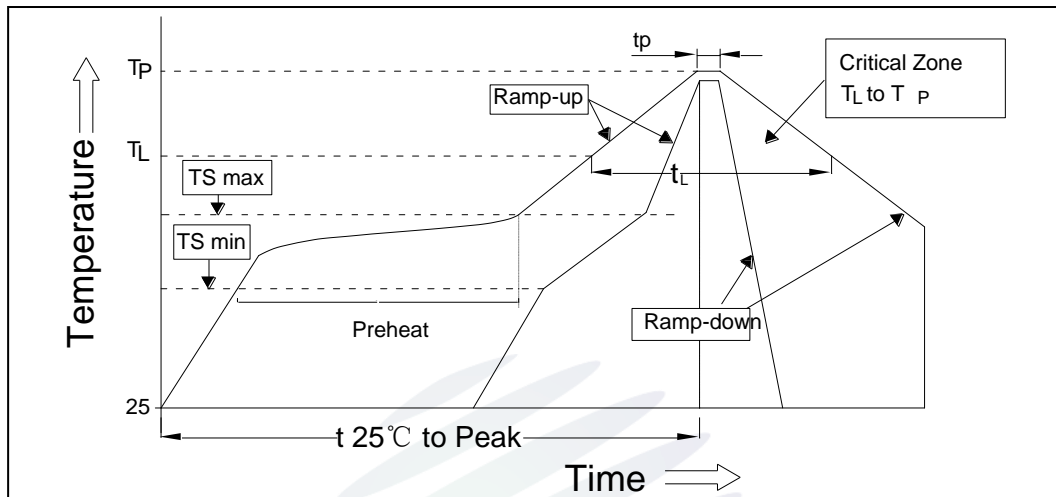

Fig.3-1 SMT Reflow Soldering Instructions SMT

Table 3-1 SMT Reflow Soldering Parameter SMT

Average temperature rise speed	Tsmax TP	3 °C/ Max 3 °C/ s
Preheating: minimum temperature	(Tsmín)	150 °C
Preheating: Max temperature	(Tsmáx)	200 °C
Preheating: Time	Tsmín Tsmax	60 - 120 60s-120s
Time limited to maintain high temperature: the temperature	(TL)	217 °C
Time limited to maintain high temperature: The Time	(tL)	60 Max 60s
Peak /Classification of temperature:	/ (TP)	260 °C
Time limit classification of peak temperature time	tp	10 Max 10s
Hold time within 5 °C with the actual peak temperature (TP)	(TP)	30 Max 30s
Cooling speed		6 °C/ Max 6 °C/ s
Needed time from 25 °C to Tp 25 °C		8 Max 8 minutes

Notes

(1) Reflow soldering should not be done more than two times. In the case of more than 24 hours passed soldering after first, LEDs will be damaged. 13

DC

(2) When soldering , do not put stress on the LEDs during heating.

3.1.1 Soldering Iron

(1) When hand soldering, keep the temperature of iron below less 300 less than 3 seconds

2/1 2

1(The hand solder should be done only one time.

3.1.2 Repairing

Repair should not be done after the LEDs have been soldered. When repairing is unavoidable,a double-head soldering iron should be used (as below figure). It should be confirmed in advance whether the characteristics of LEDs will or will not be damaged by repairing.

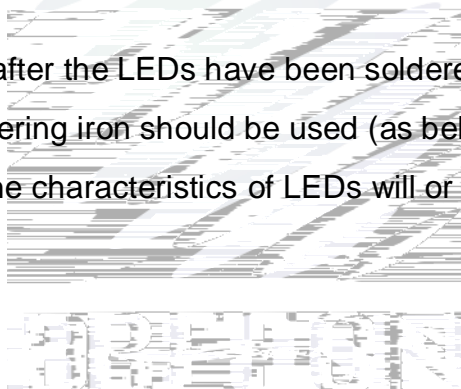

LED

DC

3.1.3 Cautions

(1) The encapsulated material of the LEDs is silicone. Therefore the LEDs have a soft surface on the top of package. The pressure to the top surface will be influence to the reliability of the LEDs. Precautions should be taken to avoid the strong pressure on the encapsulated part. So when use the picking up nozzle, the pressure on the silicone resin should be proper. DC

DC

(2) Do not apply mechanical force or excess vibration during the cooling process to normal temperature after soldering. Do not rapidly cool device after soldering.



(4) Handle the component along the side surface by using forceps or appropriate tools; do not directly touch or Handle the silicone lens surface, it may damage the internal circuitry.

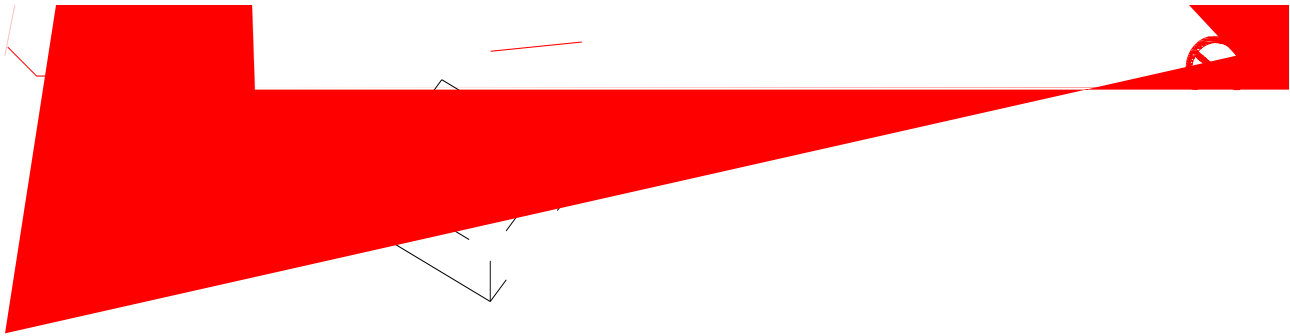
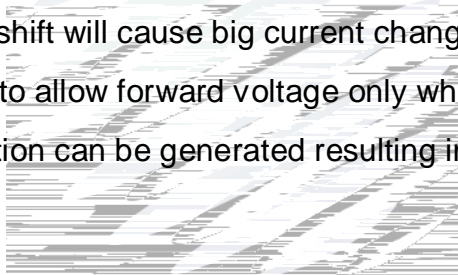

Fig 4-1 Misoperation

(5) In designing a circuit, the current through each LED can not exceed the absolute maximum rating specified for each LED. In the meanwhile, resistors for protection should be applied, otherwise slight voltage shift will cause big current change, burn out may happen. The driving circuit must be designed to allow forward voltage only when it is ON or OFF. If the reverse voltage is applied to LED, migration can be generated resulting in LED damage.

DC



DC

(6) Thermal Design is paramount importance because heat generation may result in the Characteristics decline, such as brightness decreased, Color change and so on. Please consider the heat generation of the LEDs when making the system design. LED

DC

(7) Compared to standard encapsulants, silicone is generally softer, and the surface is more likely to attract dust requiring special care during processing. In cases where a minimal level of dirt and dust particles cannot be guaranteed, a suitable cleaning solution must be applied to the surface after the soldering of components. Refond suggests using isopropyl alcohol for cleaning. In case other solvents are used, it must be assured that these solvents do not dissolve the package or resin. Ultrasonic cleaning is not recommended. Ultrasonic cleaning may cause

damage to the LED.

DC

Table 4-1 Storage

Conditions		Temperature	Humidity	Time
Storage 儲存	Before Opening Aluminum Bag	30	75%	Within 1 Year From Date
	After Opening Aluminum Bag	30	60%	24hours 24
Baking		60 ± 5		24hours 24

(8) If the moisture absorbent material (silica gel) has faded away or the LEDs have exceeded the storage time, baking treatment should be performed after unpacking and based on the following condition $(60 \pm 5)^\circ\text{C}$ for above 24 hours.

5/ 4 13

If the package is flatulence or damaged, please notify the sales staff to assist.

(9) Similar to most Solid state devices; LEDs are sensitive to Electro-Static Discharge (ESD) and Electrical Over Stress (EOS).

DC

(10) Other points for attention, please refer to our relevant information.

