



Contents 目录

1. Description 产品介绍	3
1.1 General Description 产品描述	3
1.2 Features 产品特征	3
1.3 Application 产品应用	3
1.4 Package Dimension 封装尺寸	4
1.5 Product Parameters 产品参数	5
1.6 Bin Range Of Forward Voltage and Luminous Flux (IF=150mA) 电压与流明分 BIN 范围 (IF=150mA)	7
1.8 Typical optical characteristics curves 典型光学特性曲线	9
2. Packaging 产品包装	13
2.1 Packaging Specification 包装规格	13
2.1.1 Carrier Tape Dimension 载带尺寸	13
2.1.2 Reel Dimension 卷盘尺寸	13
2.1.3 Label Form Specification 标签规格	14
2.2 Moisture Resistant Packing 防潮包装	14
2.3 Cardboard Box 包装纸箱	14
2.4 Reliability Test Items And Conditions 可靠性测试项目及条件	15
2.5 Criteria For Judging Damage 失效判定标准	16
3. SMT Reflow Soldering Instructions SMT 回流焊说明	17
3.1 SMT Reflow Soldering Instructions SMT 回流焊说明	17
4. Handling Precautions 产品使用注意事项	19
4.1 Handling Precautions 产品使用注意事项	19

1. Description 产品介绍

1.1 General Description 产品描述

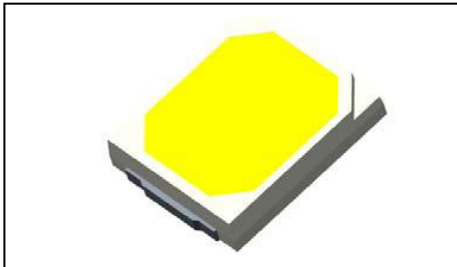

The White LED which was fabricated using a blue chip and the phosphor

Product Package: 2.8mmX3.5mmX0.7mm.

该产品为白光 LED，是由蓝光芯片激发荧光粉而形成。产品尺寸：2.8mmX3.5mmX0.7mm。

1.2 Features 产品特征

- ▶ PLCC Package. 封装
- ▶ Extremely wide viewing angle.
- ▶ Suitable for all SMT assembly and solder process. 适用于所有的SMT组装和焊接工艺
- ▶ Available on tape and reel. 适用于载带及卷轴
- ▶ Moisture sensitivity level: Level 3. 防潮等级 Level 3
- ▶ RoHS compliant. 满足RoHS要求

1.3 Application 产品应用

- ▶ Indoor lighting. 室内照明
- ▶ Bulb lighting. 球泡灯
- ▶ Tubular light application. 用于日光灯管
- ▶ General indoor applications. 其它适合的室内应用

1.4 Package Dimension 封装尺寸

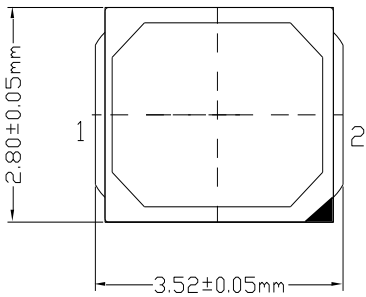

Fig.1-1 Top view 正面视图

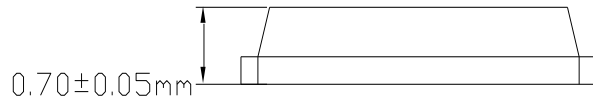

Fig.1-2 Side view 侧面视图

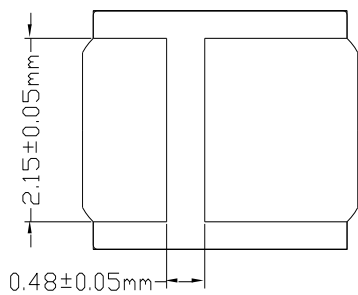

Fig.1-3 Bottom view 背面视图

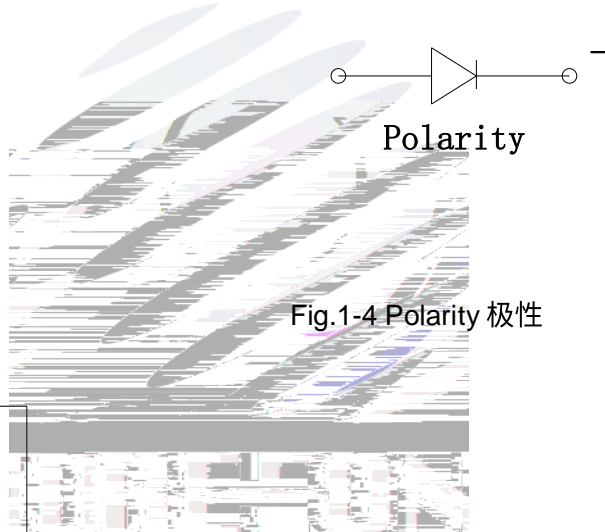

Fig.1-4 Polarity 极性

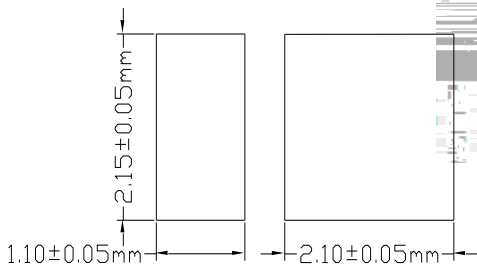

Fig.1-5 Soldering patterns 推荐焊盘

Notes 备注:

1. All dimensions units are millimeters. 所有尺寸标注单位为毫米
2. All dimensions tolerances are $\pm 0.05\text{mm}$ unless otherwise noted. 除特别标注外, 所有尺寸公差为 ± 0.05 毫米

1.5 Product Parameters 产品参数

Table 1-1 Electrical / Optical Characteristics at Ts=25°C 电性与光学特性

Item 项目	Symbol 符号	Test Condition 测试条件	Value			Unit 单位
			Min. (最小值)	Typ. (典型值)	Max. (最大值)	
Forward Voltage (正向电压)	VF	IF=150mA	2.9	3.12	3.3	V
Reverse Current (反向电流)	IR	VR=5V	---	---	10	uA
RF-P3HI32DS-FH-J ANSI	Φ	IF=150mA	60	67	80	lm
RF-P4HI32DS-FH-J ANSI	Φ	IF=150mA	65	70	80	lm
RF-P5HI32DS-FH-J ANSI	Φ	IF=150mA	65	70	80	lm
RF-WMHI32DS-FH-J ANSI	Φ	IF=150mA	65	70	80	lm
RF-P65HI32DS-FH-J ANSI	Φ	IF=150mA	65	70	80	lm
Viewing Angle (发光角度)	2θ1/2	IF=150mA	---	120	---	deg
Color Rendering Index (显色指数)	CRI	IF=150mA	80	82	---	---
Thermal Resistance. (热阻)	RTHJ-S	IF=150mA	---	---	25	/W
Electrostatic Discharge(HBM) (静电)	ESD	---	2000	---	---	V

Table 1-2 Absolute Maximum Ratings at Ts=25°C 绝对最大值

Parameter (参数)	Symbol (符号)	Rating (值)	Units (单位)
Power Dissipation (功耗)	P_D	594	mW
Forward Current (正向电流)	I_F	180	mA
Peak Forward Current (峰值电流)	I_{FP}	300	mA
Reverse Voltage (反向电压)	V_R	5	V
Operating Temperature (操作温度)	T_{OPR}	-40 ~ +100	
Storage Temperature (储存温度)	T_{OPR}	-40 ~ +100	
Junction Temperature (结温)	T_J	125	

Notes 备注:

- 1/10 Duty cycle, 10ms pulse width. 脉宽10ms,占空比1/10.
- The above forward voltage measurement allowance tolerance is $\pm 0.1V$. 正向电压测量允许公差为 $\pm 0.1V$.
- The above color coordinates measurement allowance tolerance is ± 0.003 . 以上所示坐标测量误差 ± 0.003 .
- The above luminous intensity measurement allowance tolerance $\pm 10\%$. 上述发光强度的测试允许公差为 $\pm 10\%$.
- Care is to be taken that power dissipation does not exceed the absolute maximum rating of the product. 结温功率不能超过规定的最大值.
- All measurements were made under the standardized environment of Refond. 所有测试都是基于瑞丰现有的标准测试平台。
- When the LEDs are in operation the maximum current should be decided after measuring the package temperature, junction temperature should not exceed the maximum rate. LED 使用的最大电流需要根据散热条件确定, 结温不能超过最大值。

1.6 Bin Range Of Forward Voltage and Luminous Flux (IF=150mA) 串压与流明
分 BIN 范围(IF=150mA)

Table 1-3

VF(V)	G2	H1	H2	I1
	2.9-3.0	3.0-3.1	3.1-3.2	3.2-3.3
Φ (LM)	TEA	TFA	TGA	THA
	60-65	65-70	70-75	75-80

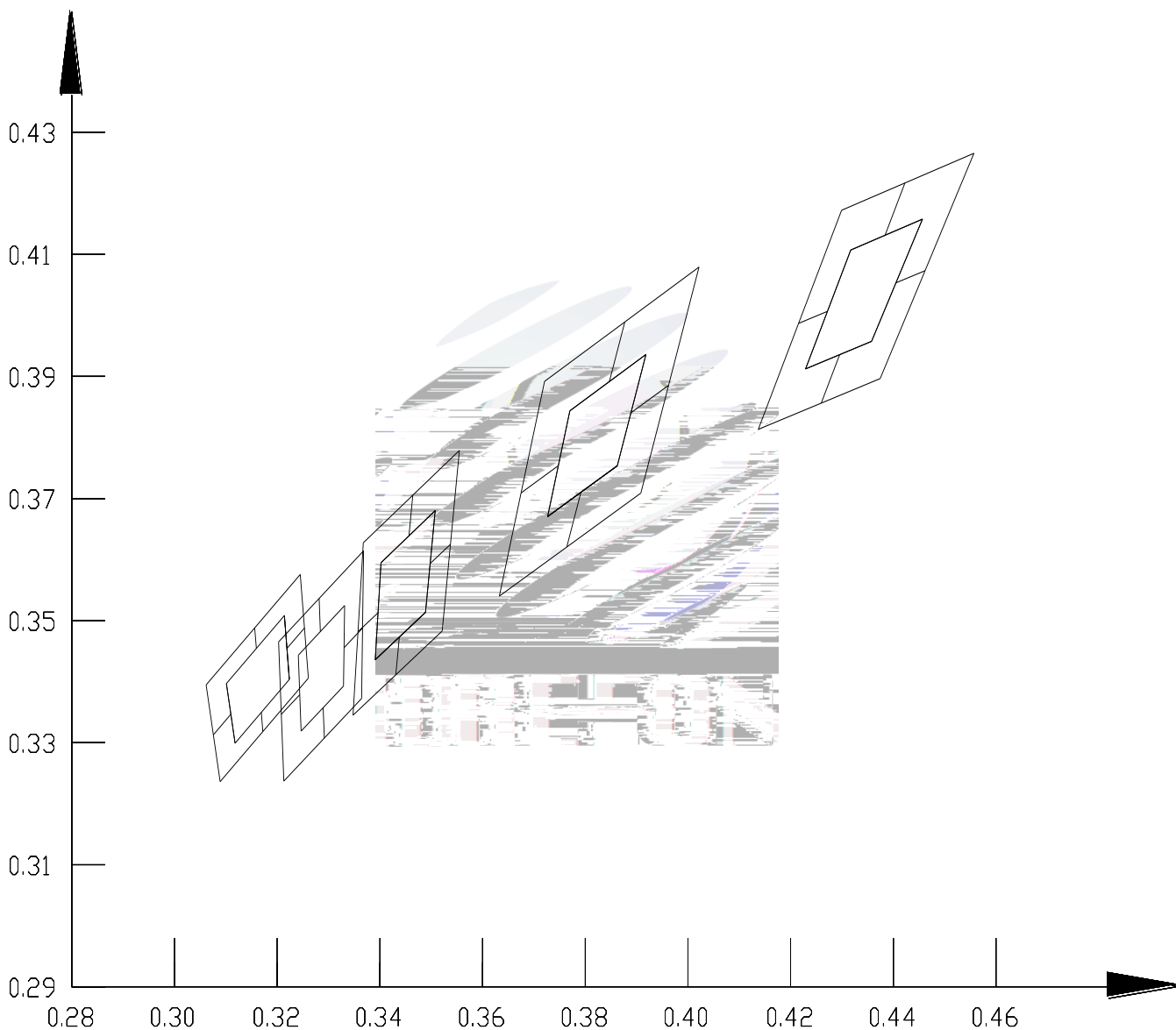

Fig 1-6 The C.I.E Chromaticity Diagram CIE色度图

Table 1-4

BIN CODE	X1	Y1	X2	Y2	X3	Y3	X4	Y4				
A30	0.4457	0.4158	0.4317	0.4107	0.4229	0.3913	0.4358	0.3958				
A40	0.3918	0.3936	0.3770	0.3844	0.3727	0.3670	0.3862	0.3754				
A50	0.3508	0.3680	0.3402	0.3595	0.3391	0.3436	0.3489	0.3514				
A57	0.3331	0.3525	0.3241	0.3443	0.3247	0.3319	0.3329	0.3393				
A65	0.3214	0.3508	0.3101	0.3397	0.3118	0.3299	0.3224	0.3404				
BIN CODE	X1	Y1	X2	Y2	X3	Y3	X4	Y4	X5	Y5	X6	Y6
A30-A	0.4423	0.4217	0.4557	0.4266	0.4462	0.4073	0.4405	0.4054	0.4457	0.4158	0.4384	0.4131
A30-B	0.4423	0.4217	0.4299	0.4172	0.4215	0.3987	0.4272	0.4007	0.4317	0.4107	0.4384	0.4131
A30-C	0.4215	0.3987	0.4137	0.3813	0.426	0.3856	0.4295	0.3936	0.4229	0.3913	0.4272	0.4007
A30-D	0.4405	0.4054	0.4358	0.3958	0.4295	0.3936	0.426	0.3856	0.4374	0.3897	0.4462	0.4073
A40-A	0.3877	0.3989	0.4022	0.4079	0.3962	0.3885	0.3889	0.3841	0.3918	0.3936	0.3847	0.3892
A40-B	0.3877	0.3989	0.3721	0.3892	0.3675	0.3709	0.3748	0.3754	0.377	0.3844	0.3847	0.3892
A40-C	0.3675	0.3709	0.3633	0.354	0.3764	0.3621	0.3791	0.371	0.3727	0.367	0.3748	0.3754
A40-D	0.3889	0.3841	0.3862	0.3754	0.3791	0.371	0.3764	0.3621	0.3908	0.3709	0.3962	0.3885
A50-A	0.3464	0.3706	0.3555	0.3779	0.3537	0.3625	0.3498	0.3593	0.3508	0.368	0.3457	0.3639
A50-B	0.3357	0.3482	0.3368	0.3628	0.3464	0.3706	0.3457	0.3639	0.3402	0.3595	0.3397	0.3513
A50-C	0.3357	0.3482	0.3348	0.3345	0.3431	0.3411	0.3438	0.3473	0.3391	0.3436	0.3397	0.3513
A50-D	0.3438	0.3473	0.3489	0.3514	0.3498	0.3593	0.3537	0.3625	0.3521	0.3483	0.3431	0.3411
A57-A	0.3286	0.354	0.3368	0.3614	0.3366	0.3488	0.333	0.3456	0.3331	0.3525	0.3286	0.3484
A57-B	0.3286	0.354	0.3203	0.3465	0.3208	0.3347	0.3244	0.3379	0.3241	0.3443	0.3286	0.3484
A57-C	0.3208	0.3347	0.3213	0.3237	0.3289	0.3305	0.3288	0.3356	0.3247	0.3319	0.3244	0.3379
A57-D	0.3289	0.3305	0.3365	0.3372	0.3366	0.3488	0.333	0.3456	0.3329	0.3393	0.3288	0.3356
A65-A	0.3245	0.3576	0.3253	0.3488	0.3219	0.3454	0.3214	0.3508	0.3159	0.3454	0.3156	0.3488
A65-B	0.3156	0.3488	0.3062	0.3395	0.3076	0.3313	0.311	0.3346	0.3101	0.3397	0.3159	0.3454
A65-C	0.311	0.3346	0.3119	0.33	0.3169	0.335	0.3172	0.3318	0.3089	0.3236	0.3075	0.3315
A65-D	0.3253	0.3488	0.3261	0.3406	0.3172	0.3318	0.3169	0.335	0.3224	0.3403	0.3219	0.3454

1.8 Typical optical characteristics curves 典型光学特性曲线

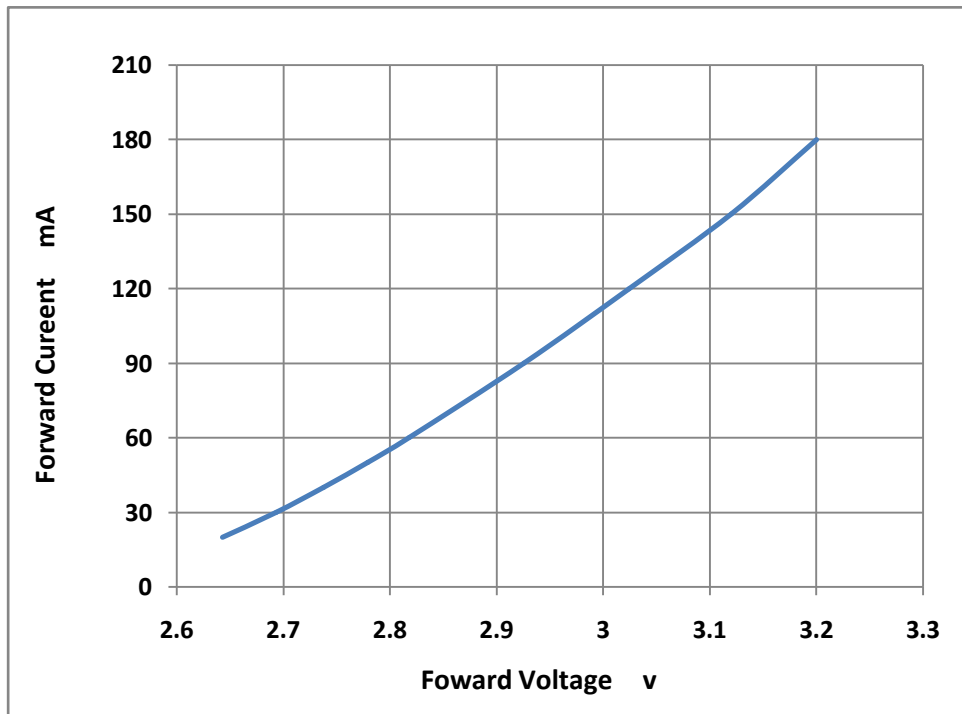

Fig 1-7 Forward Voltage Vs. Forward Current 伏安特性曲线

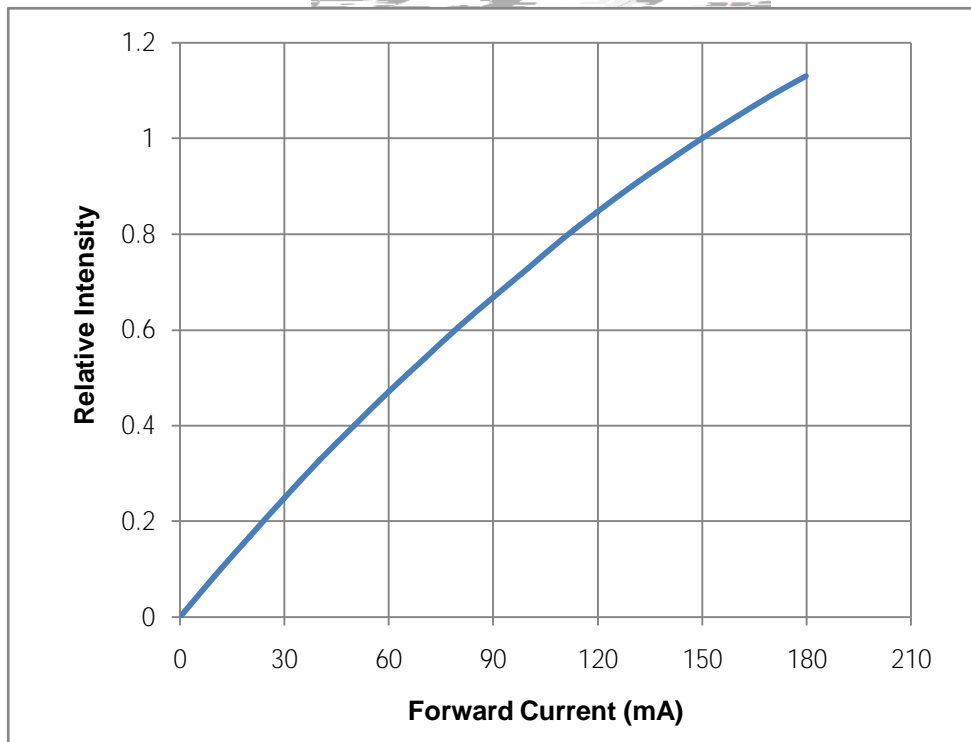

Fig 1-8 Forward Current Vs. Relative Intensity 正向电流与相对光强特性曲线

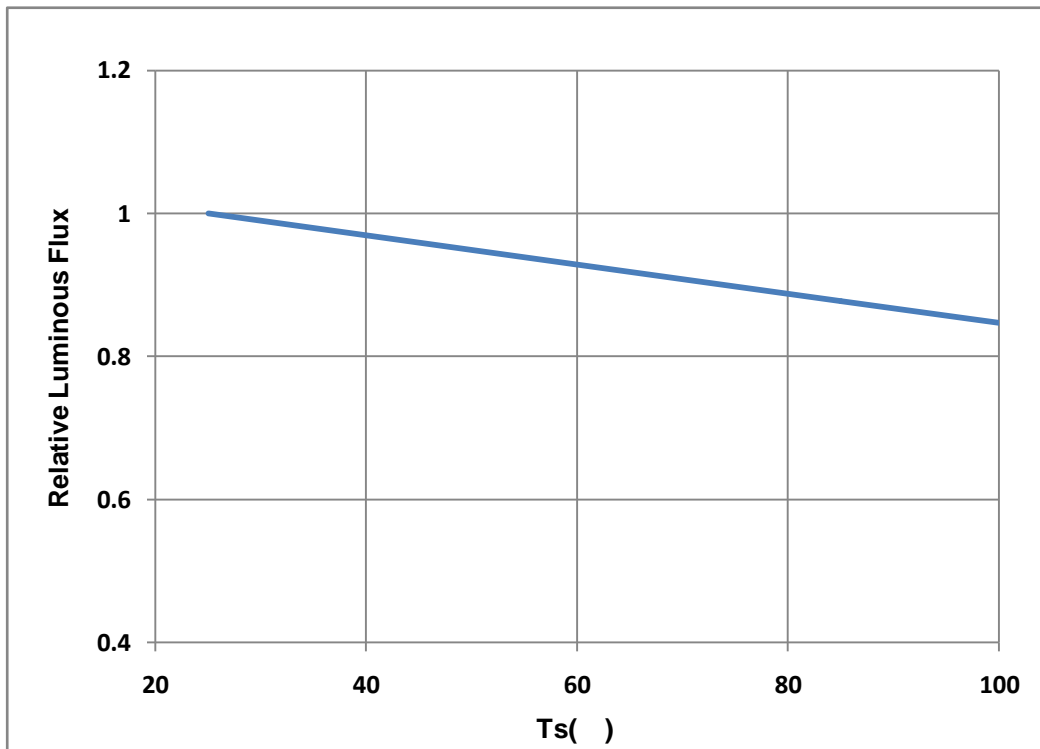

Fig 1-9 Pin Temperature Vs Relative Intensity 管脚温度与相对光强特性曲线

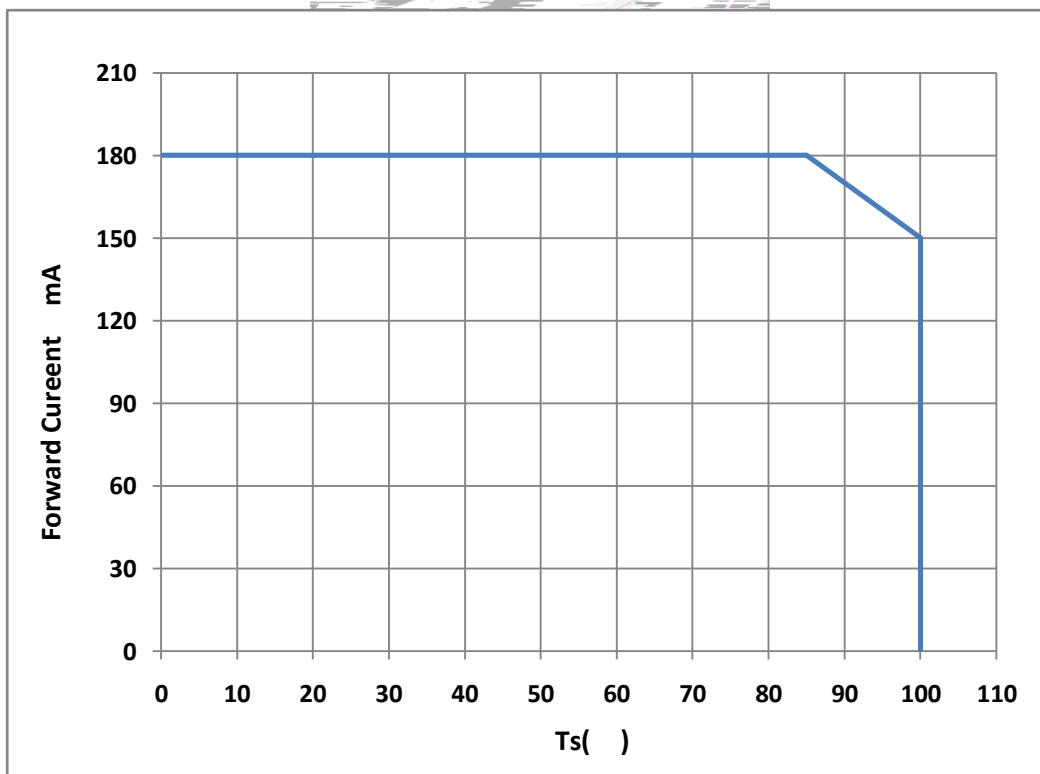

Fig 1-10 Pin Temperature Vs Forward Current 管脚温度与正向电流特性曲线

$T_j \leq 125^\circ\text{C}$

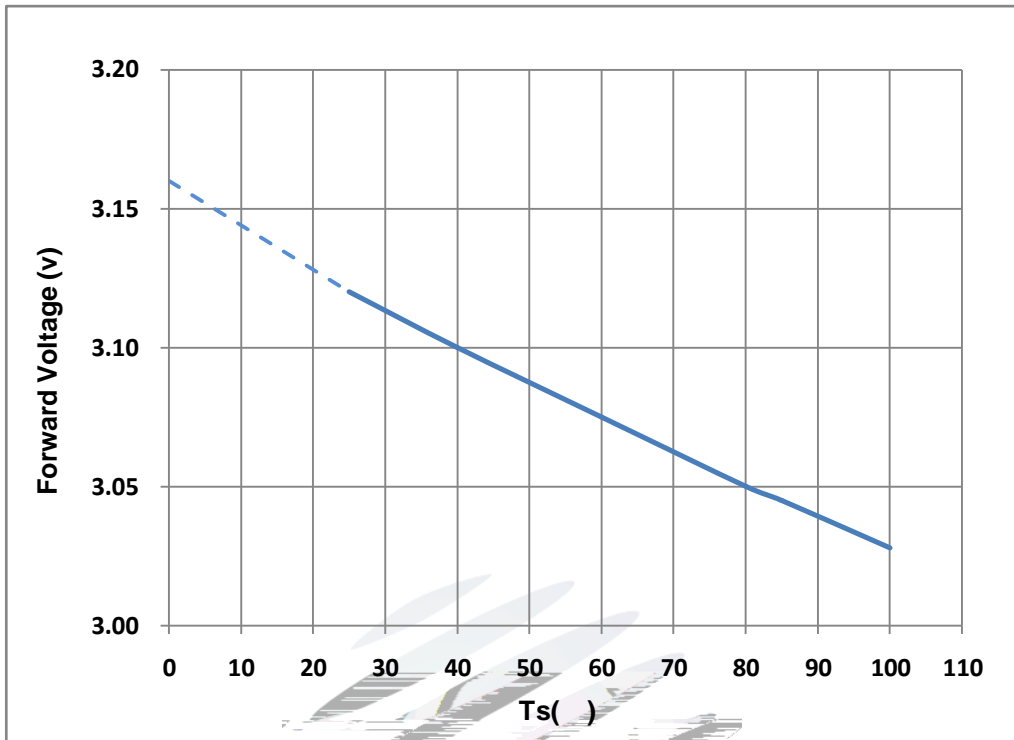

Fig 1-11 Forward Voltage Vs Pin Temperature 电压与管脚温度特性曲线

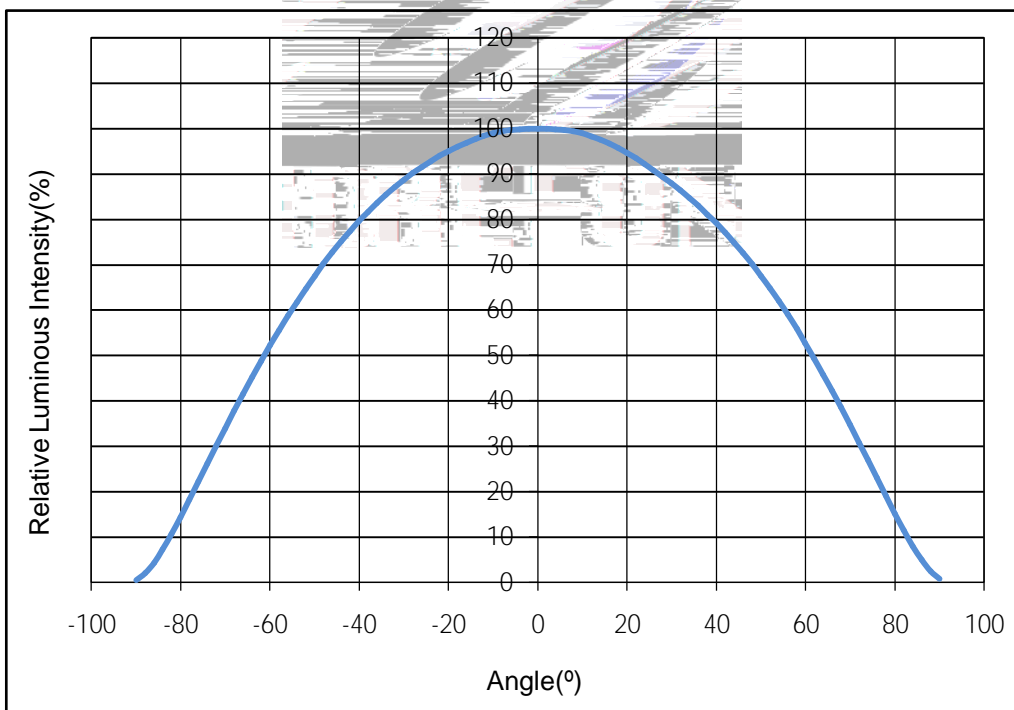

Fig 1-12 Radiation diagram 辐射特性曲线

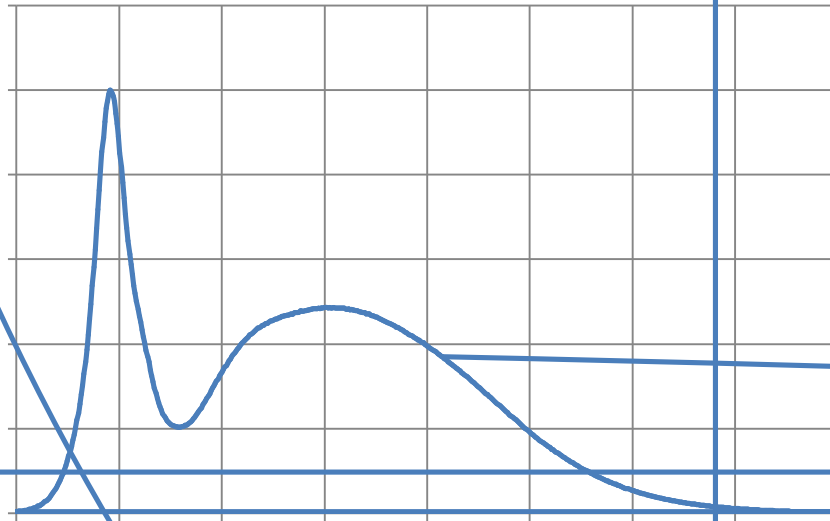
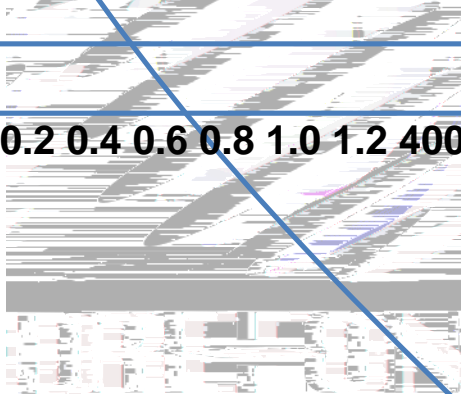

Fig 1-13 Spectrum Distribution 光谱分布特性曲线

0.0 0.2 0.4 0.6 0.8 1.0 1.2 400 450 500 550 600 650 700 750 800 Rel



2. Packaging 产品包装

2.1 Packaging Specification 包装规格

Package:12000/4000pcs/reel.包装每卷 12000/4000pcs。

2.1.1 Carrier Tape Dimension 载带尺寸

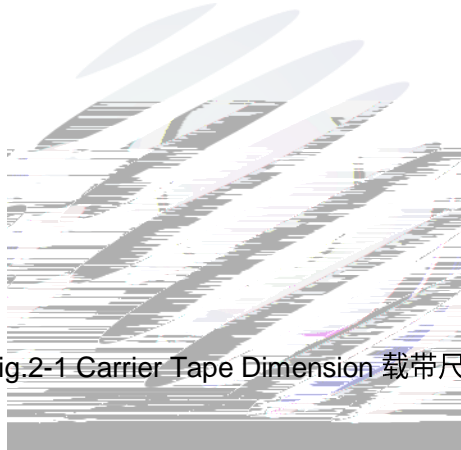

Fig.2-1 Carrier Tape Dimension 载带尺寸

2.1.2 Reel Dimension 卷盘尺寸



Table 2-1 Title

A	8.7±0.3mm	A	8.5±0.3mm
---	-----------	---	-----------

Fig.2-2Title

Notes 备注:

The tolerances unless mentioned ±0.1mm. Unit : mm注 : 未注公差为±0.1毫米, 尺寸单位 : 毫米。

2.1.3 Label Form Specification 标签规格

Table 2-2 Title

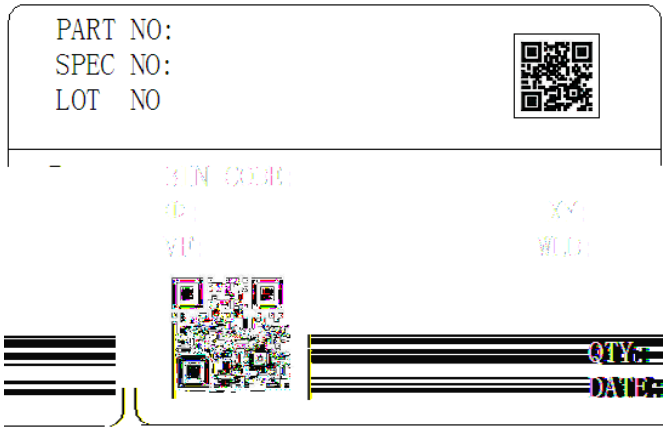

Fig 2-3 Title

PART NO.	Part Number 品名
SPEC NO.	Spec Number 规格
LOT NO.	Lot Number 批次号
BIN CODE	Bin Code 参数代码
Φ	Luminous flux luminous flux
XY	Chromaticity Bin 色区
V _F	Forward Voltage 正向电压
WLD	Wavelength 波长代码
QTY	Packing Quantity 数量
DATE	Made Date 生产日期

2.2 Moisture Resistant Packing 防潮包装

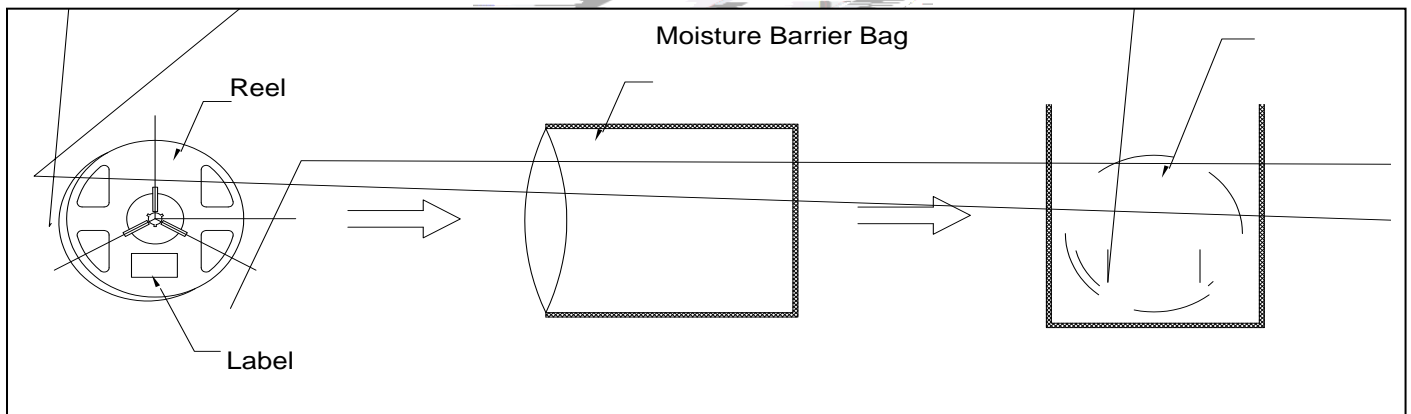

Fig.2- Title

2.3 Cardboard Box 包装纸箱

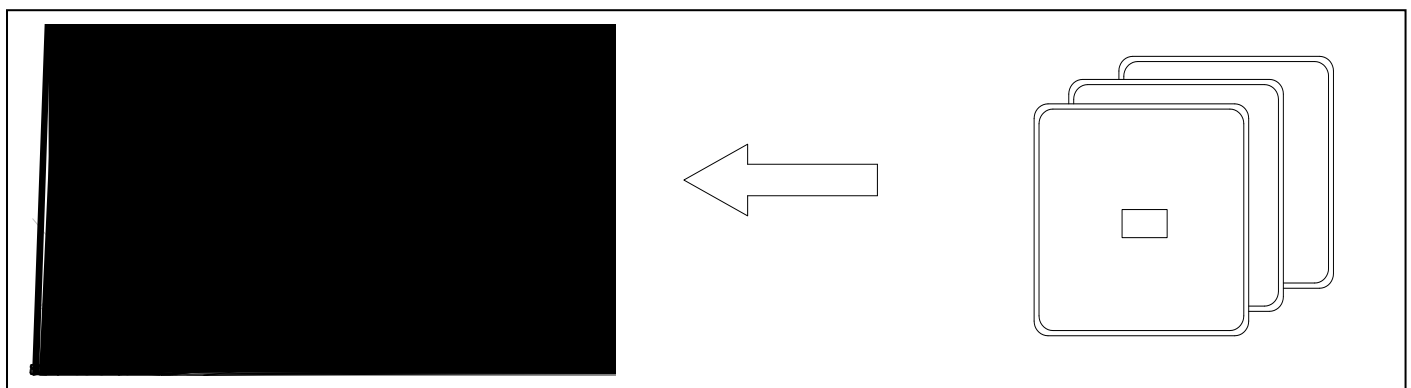

Fig.2- Title

2.4 Reliability Test Items And Conditions 信赖性测试项目及条件

Table 2-3 Title

TestItems 项目	Ref.Standard 参考标准	Test Condition 测试条件	Time 时间	Quantity 数量	Ac/Re 接收/拒收
Reflow 回流焊	JESD22-B106	Temp:260°Cmax T=10 sec	2times	10pcs	0/1
Thermal Shock 冷热冲击	JEITAED-4701 300307	-40°C 15min ↑↓10s 100°C 15min	200cycles	10pcs	0/1
High Temperature Storage 高温保存	JEITAED-4701 200 201	Temp:100°C	1000hrs	10pcs	0/1
Low Temperature Storage 低温保存	JEITA ED-4701 200 202	Temp:-40°C	1000hrs	10pcs	0/1
Life Test 常温通电	JESD22-A108	Ta=25°C If=150mA	1000hrs	10pcs	0/1
High Temperature High Humidity Life Test 高温高湿通电	JESD22-A101	60°C/ 90%RH If=150mA	1000hrs	10pcs	0/1
Temperature Humidity Storage 高温高湿储存	JEITA ED-4701 100 103	TA=85°C RH=85%	1000hrs	10pcs	0/1

2.5 Criteria For Judging Damage 失效判定标准

Table 2-4 Title

Test Items 项目	Symbol 符号	Test Condition 测试条件	Criteria For Judgement 判定标准	
			Min. 最小	Max. 最大
Forward Voltage 正向电压	V_F	$I_F=150mA$	-	$(U.S.L^*) \times 1.1$
Reverse Current 反向电流	I_R	$V_R = 5V$	-	$(U.S.L^*) \times 2.0$
Luminous Flux 光通量	Φ	$I_F=150mA$	$(L.S.L^*) \times 0.7$	-

Notes 备注:

- 1.U.S.L: Upper standard level 规格上限 L.S.L: Lower standard level 规格下限
2. The above reliability tests is based on the verification of a single/strip LED of Refond's existing experimental platform, the reliability experiment was taken under good heat dissipation conditions. when customers applies the LED to the series and parallel circuit, should take consideration of all

3. SMT Reflow Soldering Instructions SMT 回流焊说明

3.1 SMT Reflow Soldering Instructions SMT 回流焊说明



Fig.3-1Title

Table 3-1Title

Average temperature rise speed平均升温速度 (T _{max} 至T _p)	最高3 °C/秒 Max 3 °C/ s
Preheating: minimum temperature预热：最低温度 (T _{min})	150 °C
Preheating: Max temperature预热：最高温度 (T _{max})	200 °C
Preheating: Time预热：时间 (T _{min} 至T _{max})	60 - 120秒 60s-120s
Time limited to maintain high temperature: the temperature限时维持高温：温度 (T _L)	217 °C
Time limited to maintain high temperature: The Time 限时维持高温：时间 (t _L)	最多60秒 Max 60s

Peak /Classification of temperature:峰值

Notes 备注:

(1) Reflow soldering should not be done more than two times. In the case of more than 24 hours passed soldering after first, LEDs will be damaged. 回流焊次数不可以超过两次，两次回流焊的时间间隔如果超过24小时，LED可能由于吸湿而损坏。

(2) When soldering, do not put stress on the LEDs during heating. 当焊接时，不要在材料受热时用力压胶体表面。

3.1.1 Soldering Iron 烙铁焊接

(1) When hand soldering, keep the temperature of iron below less 300°C less than 3 seconds 当手工焊接时，烙铁的温度必须小于300°C，时间不可超过3秒。

(2) The hand solder should be done only one time. 手工焊接只可焊接一次。

3.1.2 Repairing 修补

Repair should not be done after the LEDs have been soldered. When repairing is unavoidable, a double-head soldering iron should be used (as below figure). It should be confirmed in advance whether the characteristics of LEDs will or will not be damaged by repairing.

LED 会损坏LED本身的特性。

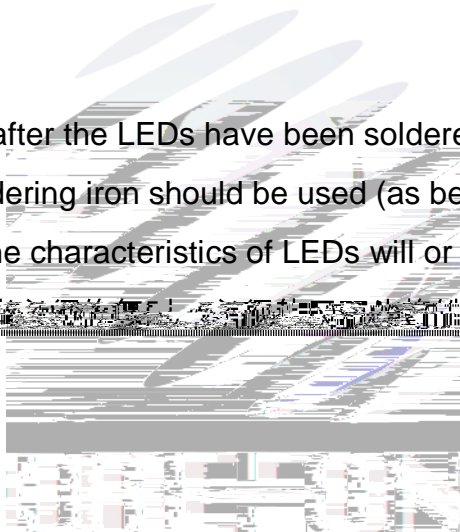

3.1.3 Cautions 注意事项

The encapsulated material of the LEDs is silicone. Therefore the LEDs have a soft surface on the top of package. The pressure to the top surface will be influence to the reliability of the LEDs. Precautions should be taken to avoid the strong pressure on the encapsulated part. So when use the picking up nozzle, the pressure on the silicone resin should be proper. LED 封装胶为硅胶，表面较软，用力按压胶体表面会影响LED可靠性，因此应有预防措施避免在按压器件，当使用吸嘴时，胶体表面的压力应是恰当的。

(2) Components should not be mounted on warped (non coplanar) portion of PCB. After soldering, do not warp the circuit board. LED 灯珠不要焊接在弯曲的 PCB 板上，焊接之后，也不要弯折线路板。

(3) Do not apply mechanical force or excess vibration during the cooling process to normal temperature after soldering. Do not rapidly cool device after soldering.回流焊之后冷却过程中，不

4. Handling Precautions 产品使用注意事项

4.1 Handling Precautions 产品使用注意事项

(1) LED operating environment and sulfur element composition cannot be over 100PPM in the LED mating usage material. This is provided for informational purposes only and is not a warranty or endorsement.LED 工作环境及与 LED 适配的材料中硫元素及化合物成份不可超过 100PPM.这只是
是一个建议，不作任何品质担保。

(2) In order to prevent external material from getting into the inside of LED, which may cause the malfunction of LED, the single content of Bromine element is required to be less than 900PPM,the single content of Chlorine element is required to be less than 900PPM,the total content of Bromine element and Chlorine element in the external EMC /P $3((e)-5(l)-175.58n)-3(te)-5(n)$





other solvents are used, it must be assured that these solvents do not dissolve the package or resin. Ultrasonic cleaning is not recommended. Ultrasonic cleaning may cause damage to the LED. 与其他封装胶相比，硅胶通常较软，表面易吸附脏物，应用时应特别注意，当对产品洁净度要求较高时，回流焊以后需要采用恰当的清洗方式，我们推荐用异丙醇作清洗剂，如需要用到其他清洗剂时请务必先在实验室验证清洗效果，以免对LED带来损害，不推荐这种清洗方式。

Table 4-1 Storage 储存

Conditions 种类	Temperature 温度	Humidity 湿度	Time 时间
Before Opening Aluminum Bag 拆包前	≤30°C	≤75%	Within 1 Year From Date 一年内
After Opening Aluminum Bag 拆包后	≤30°C	≤60%	24hours 24小时

Baking
烘烤

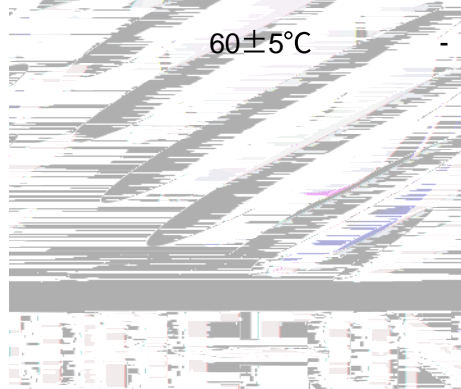

Version History/修订历史

Date日期	Revisor修订者	Version版本	Verifier审核	Remarks备注
2021-1-22		E/1		

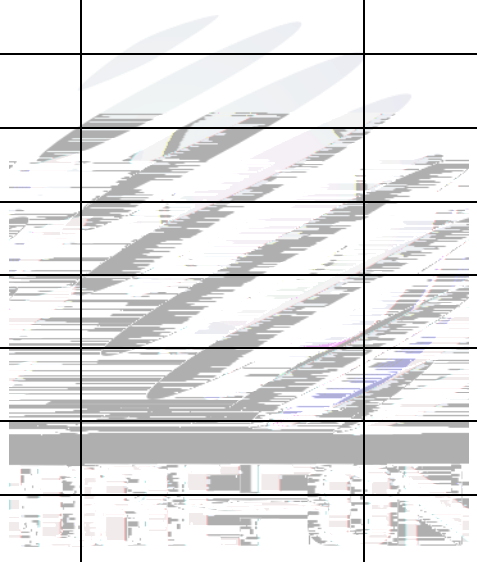

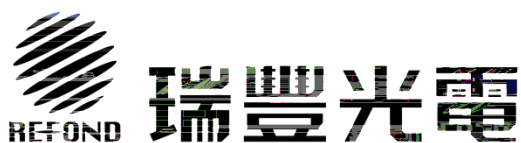

www.refond.com



Declare 申明

This specification is written both in English and in Chinese and the latter is formal.

产品规格均以中文方式书写，若有冲突以中文版本为准。